



Graphic Controls

Universal
**Recorder
Supplies**
Catalog

Your Definitive Source for Recording Charts and Marking Systems for Recorders



U^A • Universe of Solutions

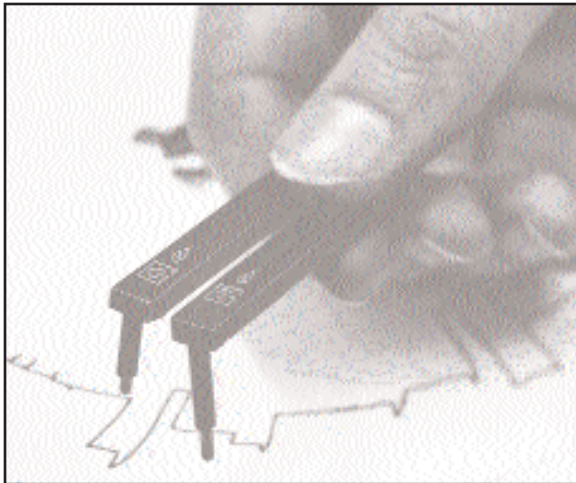

For almost 100 years, Graphic Controls has offered solutions in sensing, transmitting, recording, archiving and retrieving critical data. We've grown to become a world leader in industrial monitoring supplies, manufacturing and distributing recording charts, marking systems, graph paper and engineering pads to meet nearly every recording need.

Today, Graphic Controls is your universal source for products, services and solutions in industrial monitoring.

- To ensure fast delivery, we maintain one of the most comprehensive offerings of industrial monitoring supplies in the world.
- To provide solutions for every application, our product line is continually updated to conform with commonly used recording instruments manufactured worldwide.
- To solve special problems, we offer custom solutions manufactured to your specifications.

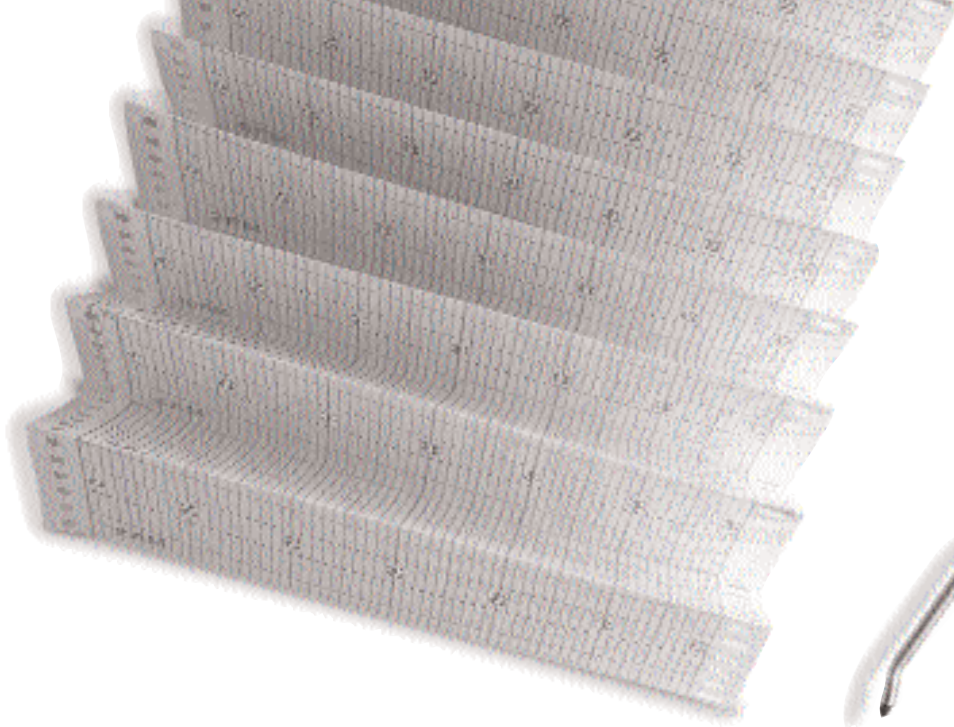

.....
From a World Class Manufacturer

Our totally integrated product line is backed by a team of knowledgeable and responsive customer service representatives. Our sales and service staff of experienced professionals is dedicated to providing you with the best available solutions, quickly and efficiently. We can offer you solutions to meet your purchasing and inventory management needs.

Graphic Controls has a long tradition of setting and meeting high quality control standards in every facet of our operation. All of our North American facilities have been awarded certification by the British Standards Institution (BSI) for meeting the stringent requirements of the International Organization for Standardization's ISO 9001 standard. We are especially proud to be among the manufacturers who have received certification to this exacting standard on our first application. You can be assured that every product we offer meets the highest quality standards and will provide you with reliable performance in the most demanding and critical operations.

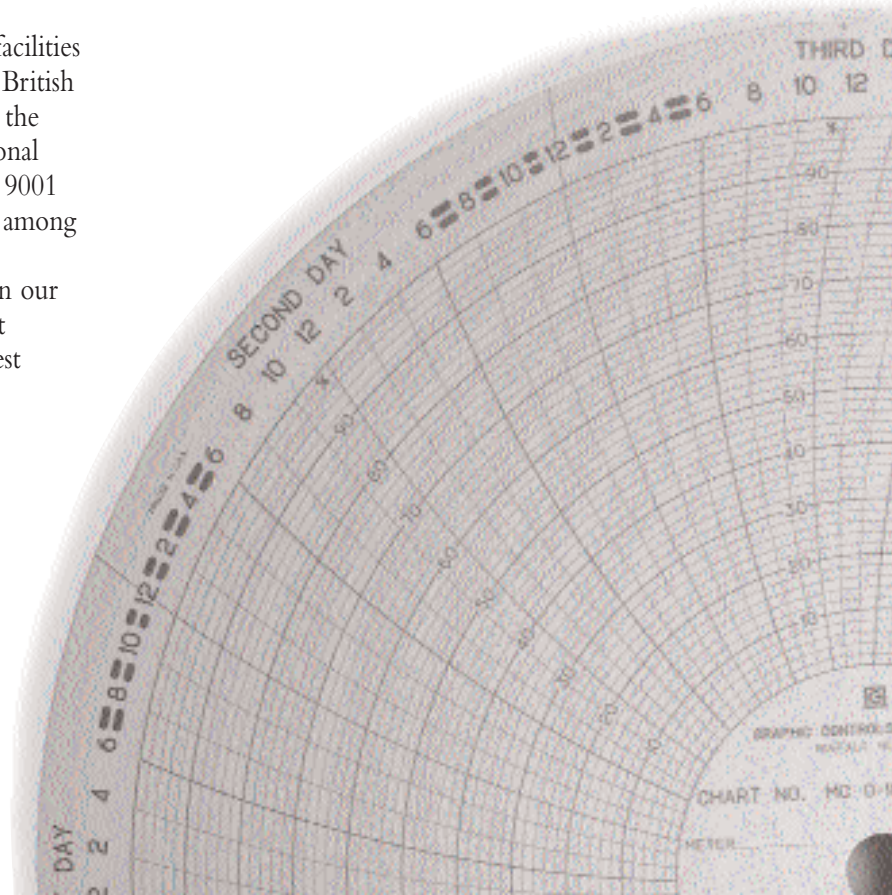

A Guide to Your Product Needs

How to Use This Catalog

.....

This catalog is a comprehensive, easy-to-use cross reference. Organized by instrument manufacturer and model number, you can consult this guide to identify the paper, pen, ink, and accessories your instrument requires. In addition, icons (shown at right) are included in the charts to provide a convenient visual key to the specific media each instrument uses.

Finding Unlisted Products

Contact your Customer Service Representative for identification and order processing if your instrument manufacturer appears on the Additional Manufacturers list or if the manufacturer and product are not shown. To better assist you, we ask that a product sample and your approximate usage be included with your inquiry.

See page 3 for Graphic Controls Customer Service phone and fax numbers, U.S., Canada and International.



Roll Chart



Circular Chart



Fanfold Chart



Plain Sheet



Rectangular Chart



Thermal



Pressure Sensitive



Electrostatic



Ink Jet



Photo Recording/
Direct Print

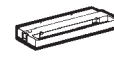

Ribbon



Disposable Pen



Bulk Ink

Table of Contents

A Guide to Your Product Needs

How to Use This Catalog2

Recorder Supplies.....5

Locating Your Charts and Disposable Pens6

Index of Manufacturers.....7

Recorder Supplies Listing.....8 – 90

Recorder Supplies Accessories91 – 95

dataGRAPHIC® Non-Impact Recording Papers and Films.....97

dataGRAPHIC® Listing98 – 107

Engineering Pads.....109

How to Order110

Engineering Pads Listing.....111

Graph Paper.....113

Graph Paper Specifications.....114

How to Order115

Graph Paper Listing116 – 119

Graph Paper Cross Reference120 – 123

Universal Series Disposable Marking Systems.....125

Universal Series Listing126 – 133

Additional Instrument Manufacturers.....134 – 135

How to Order136

Request for Quotation

Filling Out a Purchase Order

Electronic Ordering

Merchandise Returns

Product Warranty

**We Respond to
Your Needs**

Please call us!

Your solution is only a
phone call away.

USA

Buffalo, New York

800 669-1535

Fax: 800 347-2420

Canada

Gananoque, Ontario

800 267-9498

Fax: 800 267-4521

International

[Europe, Middle East]

Controles Gráficos

Ibéricos, S.A.

Tel: 34 91 7470444

Fax: 34 91 7477846

International

[All Other Countries]

Tel: 716 847-7582

Fax: 716 847-7551

Recording Supplies

Industrial Monitoring Solutions

Graphic Controls is your single source supplier for recorder products. We manufacture a wide range of recording charts, including circular, strip, rectangular and fanfold charts for a variety of ink writing, impact and non-impact applications. We also manufacture a comprehensive line of recorder marking systems, including disposable pens, pen arms, inks and accessories.

Special Charts

In addition to our extensive standard product line, we also offer the following special charts:

- **Custom Charts**
With custom features such as special ranges and grids, personalized names and identification, non-standard grid colors and papers.
- **Metric Charts**
Please supply a sample of at least 1/2 Meter in length along with a roll core.
- **Automatic Chart Changer Charts**
To fit all popular automatic chart changers. Please specify the chart changing time as well as chart automatic changer used.
- **Patented Welker* Slot Charts**
Used to enhance the reliability of the Mullins Dial-O-Graph® automatic chart changer. These charts function properly on all scanner and integrator units. Scanner blue ink, read-out holes, back-printing and over-printing available.

* U.S. Patent #4,224,629

Find Your Solutions Easily

Instrument/Model No.(s) To Fit:	Chart			Our Matching Pen or Ribbon			
	Format	Size	Order By Number	Key	P/N	Color	Order By Number
ABB Instrumentation Clearspan P70M	 KPC 006	6-3/8"	KPC P70M/7001	 KPC 005P	P106M10303	Outer Pen Blue	KPC 82-95-2013-05A
					P106M10301	Middle Pen Red	KPC 82-95-2012-05A
Clearspan P105T, PXR 105	 KPC 010	10-3/4"	KPC 105/0510		P106M10302	Inner Pen Green	KPC 82-95-1014-05A
Clearspan P100, P100M, P100S, P010, P102, P103, P600M	 KPC 004S	120mm x 90"	KPC 100/1037	 KPC 005P	P100L1005 P102L10151	2 Pen Model Red Green	KPC 64-05-1002-03 KPC 64-05-2104-03

Locating Your Charts and Disposable Pens

1. Manufacturer

Refer to Index of Manufacturers to locate your instrument manufacturer and turn to the pages indicated.

2. Instrument/Model No. - To Fit

Locate your instrument model and model number.

3. Format/Key

Identify the type of media (charts, disposable pens, etc.) you require.

4. Size

Additional information to help you determine your specific needs.

5. Order By Number - Charts



















Please reference this number when ordering chart paper.

6. Order By Number - Pen or Ribbon

This is our Graphic Controls number. Please reference this number when ordering disposable pens, ribbons, etc.

ABB Instrumentation.....	8	Gilford.....	32	Phillips Electronic	
ABB Metrawatt (See NGI)		Gould/Brush	32	Instruments	66
Acme Gravimeter	9	Graphtec.....	37	Photo Recording/Direct	
Allen Datagraphic (See Houston)		Grason-Stadler	39	Print Papers	66
American Meter	9	Gulton (See dataGRAPHIC®)		Printrex (See dataGRAPHIC®	
American Sterilizer/AMSCO ...	10	Hagan/Westinghouse/C.C.D.		and Well Loggers & Recorders)	
Ametek Systems/U.S. Gauge.....	10	Rosemount.....	40	Rank Taylor Hobson.....	67
Amprobe	10	Hays/Republic	40	Raytheon.....	67
Anderson Instruments.....	10	Hewlett-Packard	41	Rikadenki (See Soltec Rikadenki)	
Angus Electronics	11	Hitachi	46	Robertshaw	68
Applied Physics (See Varian/Cary)		Honeywell.....	46	Rockwell.....	68
Astro-Med	12	(See also Leeds & Northrup)		Rosemount.....	69
Axiom (See dataGRAPHIC®)		Houston Instruments	49	Rustrak.....	69
Bacharach	14	Illinois Tool.....	49	Schlumberger	
Badger Meter.....	14	Instron	50	(See Well Loggers & Recorders)	
Bailey-Fischer & Porter		IRD Mechanalysis		Seiko	70
(See Bailey Controls)		(See dataGRAPHIC®)		Sekonic.....	71
(See Fischer & Porter)		ITT Barton (See our Gas		Shimadzu Scientific	
Bailey Controls	14	Measurement Catalog for details)		Instruments.....	71
Barber Colman	16	Kaye Instrument	50	Simpson Electric	72
Beckman.....	17	Kent (See ABB		Soltec/Rikadenki.....	72
Belfort (See Bendix-Friez/Belfort)		Instrumentation)		Sparling	73
Bendix-Friez/Belfort	19	Kipp & Zonen.....	51	Spectra-Physics	
BIF	20	Konel-Furuno (See Furuno)		(See dataGRAPHIC®)	
Bosch (See dataGRAPHIC®)		Leeds & Northrup	51	Taylor Hobson	
Bristol.....	21	Leupold & Stevens.....	54	(See Rank Taylor Hobson)	
Builders (See BIF)		Lincoln Meter.....	54	Taylor Instruments	
Camille Bauer.....	22	Linear Instruments	55	(See ABB Instrumentation)	
Capitol Controls	23	Linseis.....	56	Tektronix.....	73
Cary (See Varian/Cary)		Lowrance	56	Texas Instruments	74
Chessell (See Eurotherm Chessell)		Marshalltown Instrument		H.O. Trerice.....	74
Chino Works American.....	23	(Motoco)	57	United Electric Controls.....	75
Cleveland Controls	23	Masoneilan	57	Uster	76
Consolidated.....	23	Mercury Instrument.....	57	Varian, Varian Associates	
dataGRAPHIC®	97	MFE Corp.....	57	(See Varian/Cary)	
Devar.....	24	Micromeritics	58	Varian/Cary.....	76
Dickson	24	M-Tek (See Molytek)		Wallace & Tiernan	78
Eberline Instrument	25	Molytek (Lab Data Controls) ...	58	Warren Automatic Controls	
Electric Tachometer	25	Monsanto	58	(Tagliabue)	79
Esterline Angus		Moore Products.....	58	Watanabe (See Graphtec)	
(See Angus Electronics)		Motorola/Westinghouse/		Weather Measure &	
Eurotherm Chessell	25	C.C.D./Rosemount.	59	Weathertronics.....	79
Fischer & Porter	27	NGI/Norma Goertz		Weksler.....	80
Fisher Controls	28	Instruments	59	Well Loggers & Recorders.....	81
Foster Cambridge	28	Nippon Denshi Kagaku	59	Weschler Instruments.....	83
Foxboro	28	Okhura Electric	60	Western Graphtec (See Graphtec)	
Fuji Electric.....	30	Omega Engineering.....	60	Westinghouse/C.C.D./	
Furuno	30	Palmer	62	Rosemount.....	83
General Electric.....	31	Partlow	63	Westronics	84
		Perkin Elmer.....	64	(See also Angus Electronics)	
				Yokogawa	86

Index of Manufacturers

Instrument/Model No. (s) To Fit:	Chart			Our Matching Pen or Ribbon			
	Format	Size	Order By Number	Key	P/N	Color	Order By Number
ABB Instrumentation Clearspan P70M	 KPC 006C	6-3/8"	KPC P70M/7001	 KPC 095P	P105M/0301	Middle Pen Red Inner Pen Green Outer Pen Blue	KPC 82-95-2012-05A
	Clearspan P105T, PXR105	 KPC 010C	10-3/4"		KPC 105/0510		P105M/0302
Clearspan P100, P100M, P100S, P010, P101, P102, P103, P600M		 KPC 004S	120mm x 50'	KPC 100/1037	 KPC 005P		P100L/1095 P102L/0151
	 KPC 005S	120mm x 50'	KPC 100/8034	P100L/1095 P100M/0056 P103L/0062		3 Pen Model Red KPC 64-05-1002-03 Green KPC 64-05-2004-03 Purple KPC 64-05-3006-03	
Commander PR100, PR103C	 KPC 002S	120mm x 82'	KPC PR100/9002R	 MP 201P	KPC PR100/0210	3 Color	MP 64-51-010V-01
	 KPC 010S	120mm x 39'	KPC PR100/9002F		KPC PR100/0211	6 Color	MP 64-51-020V-01
P250	 KPC 013S	12" x 100'	KPC 250M/414446		Black Image No Pen/Ribbon Required		
Pre-75J Series, 1900 Series	 TA 010C	9-3/8"	TA 110	 MP 012P	500S1150-1 500S1150-3 500S1150-2	Red	MP 82-39-0202-06
Fulscope® ER/C	 TA 110C	10-1/2"	TA 500P1225-1			Blue	MP 82-39-0103-06
12" Fulscope® 25, 76, 78, 120, 124	 TA 012C	11/1/4"	TA OP412	 MP 012P	155S175-3 155S175-4 155S175-5 155S175-6 155S175-7	#1 Red	MP 82-39-0202-06
						#1 Blue	MP 82-39-0203-06
90J, 490J, 700J, 800J	 TA 004S	4-13/32" x 65'	TA 82S400	 TA 006P	54S39 54S41 54S42	#2 Red	MP 82-39-0302-06
						#2 Blue	MP 82-39-0303-06
						#3 Purple	MP 82-39-0406-06
						#3 Red	TA 82-58-0102-03
						#2 Blue	TA 82-58-0203-03
						#3 Green	TA 82-58-0304-03













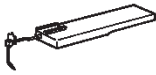









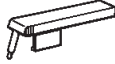
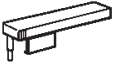

Instrument/Model No.(s) To Fit:	Chart			Our Matching Pen or Ribbon			
	Format	Size	Order By Number	Key	P/N	Color	Order By Number
ABB Instrumentation (Continued) 530, 630J, 830J, 870J, 930J, 970J (Old Style)	 TA 004S	4-13/32" x 65	TA 82S400	 TA 006P	54S45	#1 Red	TA 82-58-0602-03
					54S46	#2 Blue	TA 82-58-0703-03
				530J, 630J, 830J, 870J, 930J, 970J (New Style)			
					54S126	#2 Green	TA 82-58-1004-03
					54S127	#3 Blue	TA 82-58-1103-03
1320, 1330, 1400, 1410				 TA 004P	54S135	#1 Red	TA 82-52-1012-02
					54S136	#2 Green	TA 82-52-0014-02
					54S137	#3 Blue	TA 82-52-2013-02
					54S138	#4 Purple	TA 82-52-3016-02
Various	 TA 003S	3-1/4" x 66"	TA 82P53	Please call us for your specific application			
30	 TA 005S	4-5/16" x 49"	TA 82S1		Black Image No Pen/Ribbon Required		
	 TA 301S	4-5/16" x 40"	TA 82S2 Film				







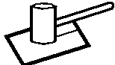









ABB Metrawatt — See NGI, pg. 59









Acme Gravimeter <i>See our Gas Measurement Catalog for more details.</i>							
Gas Gravimeters	 RY 010C	10"	RY R-2410 Series RY R-2475 Series	 MP 012P	Universal Series 39 Pens	Red Blue Green	MP 82-39-0202-06 MP 82-39-0103-06 MP 82-39-0304-06

Allen Datagraph — See Houston, pg. 49





American Meter <i>See our Gas Measurement Catalog for more details.</i>							
VPT, DRL-FO, All 8" & 9" Pressure & Temperature Recorders	 MC 005	8-7/8"	MC AR-100	 MP 012P	Universal Series 39 Pens	Black	MP 82-39-0101-06
		8"	MC P-100			Red	MP 82-39-0202-06
						Blue	MP 82-39-0303-06
						Green	MP 82-39-0404-06
						Purple	MP 82-39-0406-06









Instrument/Model No.(s) To Fit:	Chart			Key	Our Matching Pen or Ribbon				
	Format	Size	Order By Number		P/N	Color	Order By Number		
American Meter (Continued) A-88, All 12" Pressure & Differential Recording Meters	 MC 012	11-1/4"	MC M-100-H MC L-10 MC MP-100 MC O-100%	 MP 016P	Series 72 Gas Pens	Black Black	MP 82-72-0151	MP 82-72-0161	
				 MP 025P			Series 79 Gas Pens	Red Red	MP 82-79-0352 MP 82-79-0362
American Sterilizer/AMSCO Various	 AMS 006C	6"	AMS P-56396-503	 MP 012P	P-764315-403 P-764315-404	#1 Red #2 Blue	MP 82-32-0212-06	MP 82-32-0223-06	
	 AMS 008C	6-1/4"	AMS 93707	 MP 006P			P-764321-741	Red	MP 82-12-0272-05
Ametek Systems/ U.S. Gauge 6" Circular Recorder	 USG 006C	6-3/16"	USG P Series USG S Series USG V Series	 MP 015P	-	Black Red Blue Green Purple	MP 82-60-0021-06	MP 82-60-0012-06	
9" Circular Recorder	 USG 009C	7-3/4" to 8-7/8"	USG 9000 Series				MP 82-60-0013-06	MP 82-60-0014-06	MP 82-60-0016-06
12" Circular Recorder	 USG 012C	11-7/8"	USG 1200 Series						
Amprobe Ammeter Temperature Event Pyrometer Volt/Ammeter Voltmeter	 AMP 002S	2-1/2" x 30'	AMP 835X3A	 AMP 002S	Black Image No Pen/Ribbon Required				
			AMP 850A						
			AMP 800S-6						
			AMP 300SVA						
Anderson Instruments A-100, A-200, B-100	 AI 012C	11-1/8"	AI A1 AI E10 AI G Series AI H Series AI 41371	 MP 012C	Universal Series 39 Pens	Red Blue Green	MP 82-39-0202-06 MP 82-39-0103-06 MP 82-39-0304-06		

Instrument/Model No.(s) To Fit:	Chart			Our Matching Pen or Ribbon			
	Format	Size	Order By Number	Key	P/N	Color	Order By Number
Angus Electronics A 601C, 601R, 609C Single Pen	 EST 006S	5-31/32" x 103'	EST 4320	 EST 006P	8510 Pen 8516 Inkwell	Short 4.36" Red	EST 82-73-1002-02
	A 602C Dual Pen				14644 Pen 14616 Inkwell	Long 5.69" Red	EST 82-73-2002-02
Mini Servo 401C, 411B	 EST 004S	4-15/16" x 100'	EST 59006	 MP 006P	723A26 723A26-BE 723A26-BK	.370" Red Blue Black	MP 82-11-0012-05 MP 82-11-0013-05 MP 82-11-0011-05
	 EST 004S	4-15/16" X 66'	EST 59001				
Mini Servo I, II MS 411C, 412B/C, 413B/C	 EST 004S	4-15/16" x 100'	EST 59006	 EST 004P	752 A900-1-6	Short .154" Blue	EST 82-36-0013-06A
	 EST 004S	4-15/16" x 66'	EST 59001		752 A900-2-6 752 A900-3-6	Middle .430" Red Long .764" Black	EST 82-36-1012-06A EST 82-36-2011-06A
Mini Servo 6	 EST 016S	10-13/16" x 82'	EST 61701	N/A			
MRL	 EST 312S	12" x 100'	EST 832D900		Black Image No Pen/Ribbon Required		
MR-100	 EST 104S	113mm x 40'	EST T09418	N/A			
Servo II® "E"	 EST 014S	11" x 100'	EST 75000		Black Image No Pen/Ribbon Required		
Speed Servo II, L1101S, L1102S	 EST 011S	11" x 120'	EST 240514	 EST 002P	70C76-101	Short Green	EST 82-34-0014-06A
					70C75-101	Long Red	EST 82-34-0022-06A

Instrument/Model No. (s) To Fit:	Chart			Key	Our Matching Pen or Ribbon		
	Format	Size	Order By Number		P/N	Color	Order By Number
Angus Electronics (Continued) Various Models	 EST 504S	120mm x 49'	EST 822B912	N/A			
	 EST 309S	9-1/4" x 164'	EST 822B14		Black Image No Pen/Ribbon Required		
	 EST 007S	5-31/32" x 84'	EST 36000		Blue Image No Pen/Ribbon Required		
402D	 EST 011S	11" x 120'	EST 7101B	 MP 006P	852-B-901-135	Short Blue Long Red	MP 82-12-0433-05
530, 540, 575					852-B-901-225		MP 82-12-0042-05
				 MP 187P	16774972	Red Black	MP 82-31-0021-04 MP 82-31-0022-04
822D10-3	 EST 111S	275mm x 69'	EST 822B903	N/A			
	 EST 112S		EST 822B904				

Applied Physics — See Varian/Carq. pg. 76

Astro-Med AG100XLA	 ASM 310S	50mm x 87'	ASM 40952943		Black Image No Pen/Ribbon Required		
Dash II	 ASM 326S	125mm x 177'	ASM 40944540				
	 ASM 325S	125mm x 148'	ASM 40944543				





Instrument/Model No.(s) To Fit:	Chart			Our Matching Pen or Ribbon			
	Format	Size	Order By Number	Key	P/N	Color	Order By Number
Astro-Med (Continued) Dash IV	 ASM 306S	140mm x 128'	ASM 41363000			Black Image No Pen/Ribbon Required	
Dash 8	 ASM 786S	8-1/2" x 128'	ASM 41391000				
Dash 10	 ASM 330S	11" x 158'	ASM 42105000				
MT-8500/MT-8800	 ASM 309S	8-1/2" x 459'	ASM MT-8500 or ASM 40813549				
MT-95K2	 ASM 304S	415mm x 394'	ASM 41399000				
MT-9500	 ASM 320S	389mm x 92'	MT-9500 92' Roll				
	 ASM 321S	389mm x 459'	ASM 40985002				
	 ASM 317S		ASM 40985979				

What Is the Shelf Life of a Thermal Chart?



While there is no universal agreement on the exact shelf life of thermal charts, tests have been conducted showing that thermal chart papers can age and lose image intensity in less than a year if improperly stored.



Ultraviolet light wave radiation and humidity changes are enemies to these charts and can shorten archival life if improperly archived. The trace or image can fade quite rapidly if exposed to normal daylight for extended periods. Backgrounds can fade or yellow. Fingerprints, inks, solvent markers, highlighters, plastic sheet protectors, pen inks and other materials can interact with the thermal coating and mar the image or cause it to disappear altogether. Blue-trace papers can fade while in direct sunlight.



Storage is recommended in ambient conditions of 72°F and 50% R.H. to maintain the integrity of a thermal chart. Avoid plasticizers, diazo blueprint copiers and other active materials. Storage in a manila file folder in a normally dark area (e.g., a file cabinet) is also recommended.















Instrument/Model No.(s) To Fit:	Chart			Our Matching Pen or Ribbon			
	Format	Size	Order By Number	Key	P/N	Color	Order By Number
Astro-Med (Continued) MT-95000	 ASM 318S	415mm x 559'	ASM 41342549 or ASM 41342750 Slow Speed			Black Image No Pen/Ribbon Required	
	 ASM 318S		ASM 41342000				
Super 8	 ASM 319S	513mm x 100'	ASM 40025				















Axiom — See dataGRAPHIC® section, pg. 98

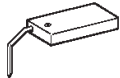









Bacharach Various	 BH 006C	6"	BH 22-0419	Call us for your specific application.
	 BH 004C	4-15/16"	BH 14-0044	
	 BH 015R	6-7/8" x 13-19/32"	BH 122-0086	















Badger Meter 2600, 2700, 3000	 BM 010 BM 012	11-3/4"	BM 510466 BM 4055-L	 MP 004P	-	MP 82-09-0162-05
----------------------------------	---------------------------------------------------------------------------------------------------------	---------	------------------------	------------------------------------------------------------------------------------------------	---	------------------







Bailey Controls See Accessories section, pg. 91, for Pen Arms. C, D, K, L, W, WS	 BA 012C	11-1/4"	Call us to order any chart for this recorder.	 MP 011P	1948561A1 1948561A2 1948561A3 1948561A4	#1 Outer Red MP 82-76-1002-03 #2 Blue MP 82-76-2003-03 #3 Green MP 82-76-3004-03 #4 Inner Purple MP 82-76-4006-03
				 MP 012P	-	Red MP 82-39-0102-06 Blue MP 82-39-0303-06 Green MP 82-39-0204-06 Purple MP 82-39-0406-06

Instrument/Model No.(s) To Fit:	Chart			Our Matching Pen or Ribbon			
	Format	Size	Order By Number	Key	P/N	Color	Order By Number
Bailey Controls (Continued) E100, KM55, WM55	 BA 008C	7-29/32"	Call us to order any chart for this recorder	 MP 011P	1948561A1 1948561A2 1948561A3 1948561A4	#1 Outer Red #2 Blue #3 Green #4 Inner Purple	MP 82-76-1002-03 MP 82-76-2003-03 MP 82-76-3004-03 MP 82-76-4006-03
				 MP 012P	—	Red Blue Green Purple	MP 82-39-0102-06 MP 82-39-0303-06 MP 82-39-0204-06 MP 82-39-0406-06
GE-MAC 12"	 BA 012S	11-31/32" x 120'	BA 12123	Call us for your specific application.			
KL	 TA 004S	4-26/64" x 65'	TA 5323760A1	 TA 006P	54S42	Short Blue Medium Red Long Green	TA 82-58-0203-03 TA 82-58-0102-03 TA 82-58-0304-03
RE1	 CLH 004S	120mm x 52'	CLH GD200078	 CLH 002P	LA 125451 —	Inner Red Blue	CLH 82-45-0012-03 CLH 82-45-0013-03
	 CLH 003S	120mm x 26'	CLH GD200190		LA 125452 — LA 125453	Middle Red Blue Outer Green	CLH 82-45-1012-03 CLH 82-45-1013-03 CLH 82-45-2014-03
RE2	 CLH 004S	120mm X 52'	CLH GD200078	 CLH 010P	LA 128969	Multi	CLH 64-08-100V-01
	 CLH 003S	120mm x 26'	CLH GD200190				
SWC	 CLH 009C	10"	CLH GDTW0050U050	 MP 203P	203111 203112 203113 203114	#1 Blue #2 Red #3 Green #4 Black	MP 82-88-0103-05 MP 82-88-0202-05 MP 82-88-0304-05 MP 82-88-0401-05
SWR Signaflex	 BA 005S	5-5/8" x 65'	BA SA100	Call us for your specific application.			











Instrument/Model No. (s) To Fit:	Chart			Our Matching Pen or Ribbon			
	Format	Size	Order By Number	Key	P/N	Color	Order By Number
Bailey Controls (Continued) 520, 521, 530, 531, 731, 732, 733, 743	 BA 002S	4-11/32" x 65'	BA 6050K10-700	 MP 189P	215K90P0002	Long Black	MP 82-12-0381-05
771, 772, 773 (Prior to 1984)	 BA 003S	4-53/64" x 50'	BA FA100	 BA 006P	2157B01P0001	#1 Long Red	BA 82-38-2012-03
	 BA 004S		BA RA100		2157B01P0002		Blue
				2157B01P0003	#3 Short Green		BA 82-38-0014-03
771, 772, 773 (Mfr. after 1984) Enhanced Vis. Rec.	 BA 003S	4-53/64" x 50'	BA FA100	 MP 189P	2157B03P0001	Red	MP 82-70-2012-03
	 BA 004S		BA RA100		2157B03P0002		Blue
				2157B03P0003	Green		MP 82-70-0014-03
Barber Colman Co. KMR 1,2,3	 KPC 010C	10"	KPC 105/1037	 KPC 095P	P105M/0301	Middle Pen Red	KPC 82-95-2012-05A
					P105M/0302	Inner Pen Green	KPC 82-95-1014-05A
					P105M/0303	Outer Pen Blue	KPC 82-95-3013-05A
Various Models	 BC 007S	7-3/16" x 130'	BC SC-10015-2	 MP 006P	RM 688-05-01	Red	MP 82-12-0212-05
	 BC 012S	12" x 120'	BC SC-80015-2		RM 688-05-02	Blue	MP 82-12-0213-05
					RM 688-05-03	Green	MP 82-12-0214-05
					RM 688-05-04	Black	MP 82-12-0211-05
 BC 003S	3-7/16" x 70'	BC 19-1361-100324	RM 688-07-01	Blue	MP 82-12-0403-05		
			RM 688-07-02	Red	MP 82-12-0402-05		
			RM 688-07-04	Green	MP 82-12-0404-05		
			RM 688-07-03	Black	MP 82-12-0401-05		
 BC 004S	4-3/8" x 56'	BC 19-2020	RM 688-04-01	Red	MP 82-12-0262-05		
			RM 688-04-02	Blue	MP 82-12-0263-05		
			RM 688-04-03	Green	MP 82-12-0264-05		
			RM 688-04-04	Black	MP 82-12-0261-05		
			RM 688-06-01	Red	MP 82-12-0232-05		
			RM 688-06-04	Blue	MP 82-12-0233-05		



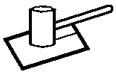











Instrument/Model No.(s) To Fit:	Chart			Our Matching Pen or Ribbon			
	Format	Size	Order By Number	Key	P/N	Color	Order By Number
Barber Colman Co. (Continued) Microprocessor	 BC 302S	2-1/4" x 63'	BC 19-2046		No Pen/Ribbon Required		
Y4M 1,2,3	 YOK 004S	113mm x 16M	YOK B9565AW	 YOK 010P  Violet: YOK 009  YOK 150P	B9565 AP B9565 AQ B9565 AR Plotter Pen B9565 AS	Red Green Blue Violet	YOK 82-24-0302-03 YOK 82-24-0204-03 YOK 82-24-0103-03 YOK 82-24-0406-03 YOK 64-11-700V-01
Beckman AccuLab™ 1-4,7-8; MicroLab™ R-18, R-18A, R-18AX; R-33	 BK 027S	7" x 100'	BK 106568 (566823) BK 181474 (566824) BK 579345 (566821)	 BK 002P	568417 568415 568416 568418	Black Red Blue Green	BK 82-14-0011-05 BK 82-14-0012-05 BK 82-14-0013-05 BK 82-14-0014-05
AccuLab™ 1-4,7-8; MicroLab™ 250, 600, IR-33			BK 573662				
AccuLab™ 1-4,6-10; MicroLab™ IR-18, IR-18A, IR-18AX, IR-20, IR-20A, IR-20AX, IR-33			BK 181476				
AccuLab™ 6, 9, 10; IR-20, IR-20A, IR-20AX	 BK 006S		BK 106541 (566825) BK 181475 (566817)				
Acta™ Century; Acta™ M; 24/25	 BK 012S	12" x 120'	BK 580216 (566802) BK 580217 (566801) BK 566809				
All Acta™ Models 24/25	 BK 074S	12" x 100'	BK 966811 BK 566429 (566810)				

Instrument/Model No.(s) To Fit:	Chart			Our Matching Pen or Ribbon			
	Format	Size	Order By Number	Key	P/N	Color	Order By Number
Beckman (Continued) BD 40/41	 KZ 009S	230mm x 66'	KZ XR-9	 KZ 068P	-	#1 Channel Red Black #2 Channel Red	KZ 82-68-0102-05 KZ 82-68-0101-05 KZ 82-68-0202-05
CR-1A	 BK 308S	8-3/16" x 170'	BK 887174		Black Image No Pen/Ribbon Required		
DK-2, DK-2A	 BK 011R	11" x 16-1/2" 100 Charts/pack	BK 12978, 12980	Call us for your specific application.			
DK-2A	 BK 002R	11" x 16-1/2" 300 Charts/pack	BK 566402 BK 566404				
DP-5500	 BK 305S	8-1/2" x 100'			Black Image No Pen/Ribbon Required		
DU-5	 BK 302S	2-1/4" x 90'	BK 886420				
DU-8	 BK 309S	245mm x 100'	BK 590491				
	 BK 307S	139mm x 150'	BK 657927		Blue Image No Pen/Ribbon Required		
Gas Chromatograph Printer	 BK 011S	180mm x 65'	BK 344-10745169	Call us for your specific application.			
IR-10	 BK 005R	7" x 24" 500 Charts/pack					
IR-4200, 4210, 4220, 4230, 4240, 4250, 4260	 BK 074S	12" x 100'	BK 566814 (101282)	 BK 002P	568417 568415 568416 568418	Black Red Blue Green	BK 82-14-0011-05 BK 82-14-0012-05 BK 82-14-0013-05 BK 82-14-0014-05

Instrument/Model No.(s) To Fit:	Chart			Our Matching Pen or Ribbon			
	Format	Size	Order By Number	Key	P/N	Color	Order By Number
Beckman (Continued) IR-4200, 4210, 4220, 4230, 4240, 4250, 4260 (Continued)	 BK 029S	12" x 120"	BK 563670 (566818) BK 563671 (566819)	 BK 002P	568417 568415 568416 568418	Black Red Blue Green	BK 82-14-0011-05 BK 82-14-0012-05 BK 82-14-0013-05 BK 82-14-0014-05
Microspec	 BK 006S	7" x 100"	BK 130852	Call us for your specific application.			
212, 915A	 LNR 011S	280mm x 100'	LNR 0100-0025	 LNR 002P	860948	Red	LNR 82-09-0132-05C
6300 Amino Acid Analyzer	 BK 053S	270mm x 53'	BK 349439	Call us for your specific application.			

Belfort — See Bendix-Friez/Belfort











Bendix-Friez/Belfort Aerovane	 FZ 010S	10-23/32" x 100'	FZ 518414	 INK 016P	518858 518383	Green Red	INK 71-50-0144-01 INK 71-50-0142-01
	 FZ 008S	4-15/16" x 100'	FZ 70467916		Black Image No Pen/Ribbon Required		
	 FZ 050S	4-31/32" x 150'	FZ 50,000,776				
	 FZ 005C	6-3/8"	FZ 70457536				
Hygro-Thermagraph Model 594	 FZ 002R	5-1/16" x 13-1/4"	FZ 207D		Please call us for bulk ink.		
	 FZ 007R		FZ 207WB				

Instrument/Model No.(s) To Fit:	Chart			Our Matching Pen or Ribbon			
	Format	Size	Order By Number	Key	P/N	Color	Order By Number
Bendix-Friez/Belfort (Continued) Hygro-Thermagraph Model 594 (Continued)	 FZ 003R	6-3/8" x 13-9/32"	FZ 4046B				Please call us for bulk ink.
	 FZ 009C	4-1/2"	FZ 20-1733				Black Image No Pen/Ribbon Required
	 FZ 011C	9-1/2"	FZ 70438789				Please call us for bulk ink.
BIF	 BIF 004C	4-5/8"	BIF J-100-W	 MP 012P	-	Black Red Blue Green	MP 82-39-0101-06 MP 82-39-0202-06 MP 82-39-0303-06 MP 82-39-0404-06
	 BIF 008C	8"	BIF Various				
232, 233, 235, 259, 301, 302, 303, 304, 305, 306	 BIF 010C	9-15/16" to 10"	BIF GR-15-D				
	 BIF 012C	11-1/4"	BIF12-100-D, BIF D-50-W,F BIF KF, M, SF, T, W				
233 Series Chrono F/O	 TA 004S	4-13/32" x 65'	TA 82S 1000	 TA 002P	-	Red Blue	TA 82-47-0012-03 TA 82-47-0043-03
257	 BIF 004	4-13/32" x 65'	BIF 1817-123				
287			BIF 147154-100				

Product and company names listed are trademarks or trade names of their respective companies.

Instrument/Model No.(s) To Fit:	Chart			Our Matching Pen or Ribbon			
	Format	Size	Order By Number	Key	P/N	Color	Order By Number

Bosch — See dataGRAPHIC® section, pg. 98







Bristol AC Ammeter/Voltmeter 3 Zone	 BR 010C	9-15/16" to 10"	Various Charts Please Call	 MP 232P	375985-01-8 375985-05-0	1-1/4" Lightweight Short Red MP 82-22-0102-06 Blue MP 82-22-0103-06 Middle Red MP 82-22-0202-06 Blue MP 82-22-0203-06 Long Blue MP 82-22-0303-06 Green MP 82-22-0304-06
	T169, 44, 530, 531, 532, 541, 616, 626, 765, 4069T, 4069TH, 4631	 BR 008C	4-15/16" to 8"			
500, 501, 565, 575, 576, 595, 596, 4300	 BR 012C	11-1/4"	BR 50003	 MP 012P	375985-21-2 375985-25-5 375985-24-7 375985-22-0 375985-26-3 375985-23-9	1-3/4" Standard Short Red MP 82-39-0102-06 Blue MP 82-39-0103-06 Middle Red MP 82-39-0202-06 Blue MP 82-39-0203-06 Long Blue MP 82-39-0303-06 Green MP 82-39-0304-06
Dynamaster 550, 570, 590	 BR 012S	12-15/64" x 120'	BR R5000			
Dynamaster 760 - 765	 BR 007S	7-3/4" x 127'	BR DS-1006	N/A		
Dynamaster 850, 4620-D, 8221; Metatronic 2000	 BR 004S	4-1/2" x 65'	BR T013	 BR 003P	386117-01-2 386117-02-0	#1 .15" Nib Red BR 82-86-1012-04 #2 .77" Nib Blue BR 82-86-1013-04
Metatronic 2711	 BR 004S	4-1/2" x 65'	BR T1013			

Stiffness: a Critical Characteristic in Circular Charts



We specify stiffness as a critical characteristic in our circular chart papers.

Consider how a circular chart rests in a recorder:
In its vertical orientation, a low Gurley stiffness value will allow the chart to flop over, rendering it useless to the reader.

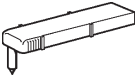
In a chart changer, a floppy chart is a guaranteed misfire, jam and loss of accuracy.

Instrument/Model No. (s) To Fit:	Chart			Our Matching Pen or Ribbon			
	Format	Size	Order By Number	Key	P/N	Color	Order By Number
Bristol (Continued) Metagraphic	 BR 003S	3-3/8" x 65'	BR BM10	N/A			
SLC 3700	 BR 304S	4-15/16" x 85'	BR 387926-02-0		No Pen/Ribbon Required		
Smoke Charts	 BR 107C BR 108C BR 111C BR 112C	8" 8" 12" 12"	BR Medium Smoke BR Heavy Smoke BR Medium Smoke BR Heavy Smoke	-			
1128	 BR 006S	5-31/32" x 96'	BR NE6009	N/A			
4390, 4392	 CLH 009C	10"	CLH GDTW 0100U100	 MP 203P	LA 203191/291 LA 203192/292 LA 203193/293 LA 203194/294	Inner Pen Blue MP 82-88-0103-05 2nd Pen Red MP 82-88-0202-05 3rd Pen Green MP 82-88-0304-05 4th Pen Black MP 82-88-0401-05 <i>See Accessories section, pg. 91, for pen arms.</i>	

Builders — See BIF, pg. 20



Camille Bauer Pointax 7P2 Linax 7K2	 CM 004S	120mm x 210'	CM 870 891	NA	851396 851403 851411	NA
Various Wide Linax	 CM 011S	230mm x 53'	CM 805442			

Ink Acceptance of Gas Charts

Low-sized, substandard paper can cause feathering, bleed-through, jamming and loss of accuracy.



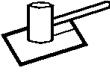

Too much sizing, on the other hand, can cause drying problems, smearing, inaccuracies and losses.



Graphic Controls sets the standard in gas charts for accurate, clean traces every time. We guarantee our chart performance when coupled with recorder pens we manufacture.

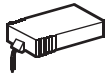

Instrument/Model No.(s) To Fit:	Chart			Our Matching Pen or Ribbon			
	Format	Size	Order By Number	Key	P/N	Color	Order By Number
Capital Controls Various	 CAP 007C	7-3/16" 50/Box	CAP R-737		No Pen/Ribbon Required		
Various	 CAP 006C	6-5/16"	CAP R-4225	 KPC 095	-	Outer Pen Blue	KPC 82-95-3013-05A
					-	Middle Pen Red	KPC 82-95-2012-05A
					-	Inner Pen Green	KPC 82-95-1014-05A



Carq — See Varian/Carq, pg. 76

Chessell — See Eurotherm-Chessell, pg. 25







Chino Works America AA	 CHO 012S	318mm x 20M	CHO AA-01001A	N/A			
AH, EH, ET	 CHO 007S	180mm x 20M	CHO EH-01001				
AL, EL	 CHO 006S	114mm x 10M	CHO EM-001	 CHO 001P/002P	22019-425301 22019-425303 22019-425302 22019-4262018	Red Blue Green Black	CHO 64-48-0022-03 CHO 64-48-0023-03 CHO 64-48-0024-03 CHO 64-48-0011-05
EA, EB	 CHO 009S	280mm x 15M	CHO EX-001				

Cleveland Controls 6400	 CCI 012C	11-1/4" OD	CCI 64001	 MP 012P	26059-1 26059-2 26059-3	#1 Red #2 Blue #3 Green	MP 82-39-0102-06 MP 82-39-0203-06 MP 82-39-0304-06
-----------------------------------	-------------------------------------------------------------------------------------------------	------------	-----------	-------------------------------------------------------------------------------------------------	-------------------------------	-------------------------------	----------------------------------------------------------

Consolidated 6" to 8-1/2"	 SB 008C	6" to 8-1/2"	Call us with your specific application.	 MP 012P	-	Black Red Blue Green	MP 82-39-0101-06 MP 82-39-0202-06 MP 82-39-0303-06 MP 82-39-0404-06
10"	 SB 010C	9-15/16"	SB 8000 SB 9002				

Instrument/Model No.(s) To Fit:	Chart			Our Matching Pen or Ribbon			
	Format	Size	Order By Number	Key	P/N	Color	Order By Number
Consolidated (Continued) 12"	 SB 012C	11-1/4"	SB 1204	 MP 012P	-	Black	MP 82-39-0101-06
						Red	MP 82-39-0202-06
						Blue	MP 82-39-0303-06
						Green	MP 82-39-0404-06

dataGRAPHIC® — See pgs. 97 - 107

Devar 18-300 27-300 28-300	 DV 004S	4-9/32" x 64'	DV M643A-1	 DV 002P	514006-01	Short Green DV 82-57-0014-06
	 DV 005S	4-17/32" x 48'	DV 508928-2027		514006-02	
Dickson DTP, EV4, PR4, PR4-10 PW4, SK4, SL4, THP, THV		 DIN 008C	4" (100/box)	DIN 12	 MP 015P	P222
	6" (100/box)		DIN 603	P226		Long Blue MP 82-60-0023-06
	8" (100/box)		DIN 417	P246 (P222 + P226)		
	6"					
CO ₂ X, ESX, PR8, PRxA, PRPR8, TH8, THD _x	 DIN 010C	10" (100/box)	DIN 818			





Curl

In chart paper manufacture, the paper machine imparts different strengths and characteristics which directly relate to the paper web's orientation to its flow through the machine. The difference between machine and cross-machine strength is quite noticeable, and a quality printer can use the differences to produce a superior chart product.



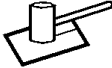

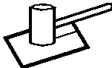





The tendency for paper to curl as a result of humidity is much higher in the cross-machine direction than it is in the machine direction. When Graphic Controls manufactures a circular chart, much care is taken to align the DOG slot in the machine direction, to ensure that curl will not impact the ability of the chart to disengage from the recorder during automatic changing.









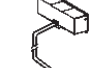





Curl in a chart can also cause the pen arm to lift the pen from the chart surface...and that means no trace!





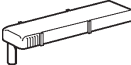

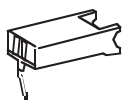

Graphic Controls strictly monitors circular chart papers to assure compliance to its specifications which call for negligible curl at AGA operating conditions.

Instrument/Model No.(s) To Fit:	Chart			Our Matching Pen or Ribbon			
	Format	Size	Order By Number	Key	P/N	Color	Order By Number
Eberline Instrument Strip Recorders (Various)	 EBR 002S	64mm x 50'	EBR 10814-CM		No Pen/Ribbon Required		
Electric Tachometer OR-4, OR-5	 ET 004S	3-3/4" x 88'	ET 36W		No Pen/Ribbon Required		
R500, R600	 ET 006S	6-15/16" x 84'	ET 736X				





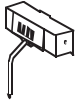





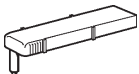





Esterline Angus — See Angus Electronics, pg. 11

















Eurotherm Chessell 300, 301	 CLH 004S	120mm x 52'	CLH GD200078	 CLH 002P	- LA 125451/202387	Inner Pen Red CLH 82-45-0012-03 Blue CLH 82-45-0013-03 Middle Pen Red CLH 82-45-1012-03 Blue CLH 82-45-1013-03 Outer Pen Green CLH 82-45-2014-03
	 CLH 003S	120mm x 26'	CLH GD200190		LA 125452/202389 -	
	 CLH 005S	120mm x 39'	CLH GD200174			No Pen/Ribbon Required
306 Multi Point	 CLH 004S	120mm x 52'	CLH GD200078	 CLH 010P	LA 128969	6 Color CLH 64-08-100V-01 Print Wheel
	 CLH 003S	120mm x 26'	CLH GD200190			
	 CLH 005S	120mm x 39'	CLH GD200174			No Pen/Ribbon Required
320	 CLH 011S	270mm x 65'	CLH GD200102	 MP 200P	LA 128961 LA 128962 LA 128963 LA 128964 LA 128965 LA 128966	Green MP 64-24-0104-01 Red MP 64-24-0202-01 Blue MP 64-24-0303-01 Black MP 64-24-0401-01 Purple MP 64-24-0506-01 Brown MP 64-24-0608-01

Instrument/Model No.(s) To Fit:	Chart			Our Matching Pen or Ribbon			
	Format	Size	Order By Number	Key	P/N	Color	Order By Number
Eurotherm Chessell (Continued) 320 (Continued)	 CLH 010S	270mm x 65'	CLH GD200103	 MP 200P	LA 128961	Green	MP 64-24-0104-01
	LA 128962				Red	MP 64-24-0202-01	
321	 CLH 011S	270mm x 65'	CLH GD 200102		LA 234423	Green	MP 64-24-1104-01
	 CLH 010S		CLH GD200103		LA 234424	Blue	MP 64-24-1303-01
					LA 234425	Red	MP 64-24-1202-01
340, 343, 344, 345	 CLH 002S	120mm x 105'	CLH GD201123	 CLH 026P	LA 243770 LA 243771 LA 243772 LA 243773	Purple Blue Red Green	CLH 82-82-0406-01 CLH 82-82-0103-01 CLH 82-82-0202-01 CLH 82-82-0304-01
346	 CLH 002S	120mm x 105'	CLH GD201123	 CLH 010P	LA 128969	6 Color Print Wheel	CLH 64-08-100V-01
	 CLH 001S		CLH GD201089				
390/392/394	 CLH 009C	10"	CLH GDTW0100U100	 MP 203P	LA 203191/203291 LA 203192/20392 LA 203193/203293 LA 203194/203294	Inner Pen Blue 2nd Pen Red 3rd Pen Green 4th Pen Black	MP 82-88-0103-05 MP 82-88-0202-05 MP 82-88-0304-05 MP 82-88-0401-05
4001, 4002	 CLH 012S	269mm x 115.5'	CLH GD236721U100	 CLH 011P	LA 232380	6 Color Ribbon	CLH 64-11-600V-01
4101C, 4102C, 4103C	 CLH 001S	120mm x 52'	GD201089	 CLH 008P	LA249551 LA249552 LA249553	Channel #1 Blue Channel #2 Red Channel #3 Green	CLH 64-23-0013-01 CLH 64-23-0012-01 CLH 64-23-0014-01

Instrument/Model No.(s) To Fit:	Chart			Our Matching Pen or Ribbon			
	Format	Size	Order By Number	Key	P/N	Color	Order By Number
Eurotherm Chessell (Continued) 4101C, 4102C, 4103C	 CLH 001S	120mm x 52'	GD201089	 CLH 008P	LA249554	Channel #4 Violet Annotation Black	CLH 64-23-0016-01
					LA249550		CLH 64-23-0010-01
4101M, 4102M, 4103M				N/A	-	-	
4180C	 CLH 016S	224mm x 22M	GD248010U100A	N/A	-	-	
4180M	 CLH 016S	224mm x 22M	GD248010U100A	 CLH 007P	LA248163		CLH 64-31-0010-01
4200 Data Recorder	 CLH 015S	274mm x 22M	CLH GD244101U100	 CLH 005P	LA 243101	Multi	CLH 64-11-210V-01
	 CLH 006S	274mm x 32M	CLH GD244109U100				
4250C	-	-	-	 CLH 006P	LA244371 LA244372 LA244373 LA244374	Green Red Blue Black	CLH 64-37-0014-01 CLH 64-37-0012-01 CLH 64-37-0013-01 CLH 64-37-0011-01
Fischer & Porter 51-1102 Electronic or Pneumatic	 FRP 012C	11-7/8"	FRP 211A001	 MP 012P	14D001U17	.14" Black Red Blue Green	MP 82-39-0101-06
					14D001U21		MP 82-39-0102-06
					14D001U25		MP 82-39-0103-06
					14D001U29		MP 82-39-0104-06
					14D001U18	.37" Black Red Blue Green	MP 82-39-0201-06
					14D001U22		MP 82-39-0202-06
					14D001U26		MP 82-39-0203-06
					14D001U30		MP 82-39-0204-06
					14D001U19	.60" Black Red Blue Green	MP 82-39-0301-06
					14D001U23		MP 82-39-0302-06
					14D001U27		MP 82-39-0303-06
					14D001U31		MP 82-39-0304-06
					14D001U20	.83" Black Red Blue Green	MP 82-39-0401-06
					14D001U24		MP 82-39-0402-06
14D001U28	MP 82-39-0403-06						
14D001U32	MP 82-39-0404-06						

New products are added every day. If the charts or disposable pens that you need are not listed, please call us.











Instrument/Model No.(s) To Fit:	Chart			Our Matching Pen or Ribbon				
	Format	Size	Order By Number	Key	P/N	Color	Order By Number	
Fischer & Porter (Continued) 1390, 1392	 FRP 010C	10"	FRP 216A001U01	 MP 203P	14D001U20	4th Pen Black	MP 82-88-0401-05	
					14D001U22		2nd Pen Red	MP 82-88-0202-05
					14D001U25		Inner Pen Blue	MP 82-88-0103-05
					14D001U31		3rd Pen Green	MP 82-88-0304-05
51-1310, 51-1321, 51-1330, 51-1340, Old & New	 FRP 004S	4-5/16" x 60'	FRP 215A010 (212A005)	 FRP 050P	410D052U02 410D053U02 410D054U02	#1 Red #2 Blue #3 Green	FRP 82-23-0202-02 FRP 82-23-0103-02 FRP 82-23-0304-02	
2342, 2343	 FRP 104S	120mm x 105'	FRP 216A020U71	 CLH 026P	14D002U01	Green	CLH 82-82-0304-01	
					14D003U01	Purple	CLH 82-82-0406-01	
	 FRP 120S	120mm x 46'	FRP 216A022U15	 CLH 026P	14D004U01	Blue	CLH 82-82-0103-01	
14D005U01					Red	CLH 82-82-0202-01		
					14D003U01	#1 Blue	CLH 82-82-0103-01	
					14D004U01	#2 Red	CLH 82-82-0202-01	
					14D005U01	#3 Green	CLH 82-82-0304-01	
					14D002U01	Annotation Pen Purple	CLH 82-82-0406-01	
Fisher Controls RD 221 RD 222 RD 1111	 FRC 004	4-23/64" x 50'	FRC 34A1034	 FRC 002	14A 2890 X022 14A 2891 X022 14A 2892 X022	Red Green Blue	FRC 82-35-0012-03 FRC 82-35-2014-03 FRC 82-35-1013-03	
RD 206	 FRC 004	4-5/16" x 60'	FRC 212A005	 FRC 002	10A 8457 X012 10A 8458 X012	#1 Red #2 Blue	FRC 82-53-5002-03 FRC 82-53-5003-03	
DRP 743	 CLH 002	120mm x 105'	CLH GD201123	 CLH 026	LA 243770 LA 243771 LA 243772 LA 243773	Purple Blue Red Green	CLH 82-82-0406-01 CLH 82-82-0103-01 CLH 82-82-0202-01 CLH 82-82-0304-01	
Foster Cambridge, Ltd. P100,	 FC 004S	120mm x 50'	FC P100L/41/7400	 KPC 005P	P100L/1095 P102L/0151	2 Pen Model Red Green	KPC 64-05-1002-03 KPC 64-05-2104-03	
					P100L/1095 P100M/0056 P103L/0062	3 Pen Model Red Green Purple	KPC 64-05-1002-03 KPC 64-05-2004-03 KPC 64-05-3006-03	
105	 KPC 010	10-3/4"	KPC 1153	 KPC 095	P105M/0301 P105M/0302 P105M/0303	Middle Red Inner Green Outer Blue	KPC 82-95-2012-05A KPC 82-95-1014-05A KPC 82-95-2013-05A	





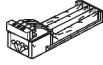







Instrument/Model No.(s) To Fit:	Chart			Our Matching Pen or Ribbon			
	Format	Size	Order By Number	Key	P/N	Color	Order By Number
Foxboro Din Recorders, E27R, 126, 127, 226, 227, 760R	 FX 104S	4-5/16" x 54'	FX 33001	 FX 006P	G0114TE G0114SW G0114SR	Short Green Middle Red Long Blue	FX 82-50-0014-03 FX 82-50-1012-03 FX 82-50-2013-03
	 FX 004S	4-5/16" x 54'	FX 53000 FX 53001 FX 53013	 FX 002P	D0129ZP D0129ZN D0129ZQ -	Harp/Pneumatic Type #1 Red #2 Green #3 Blue #4 Violet Rectangular/Electronic Type #1 Red #2 Green #3 Blue #4 Violet	FX 82-51-5012-03* FX 82-51-4014-03* FX 82-51-6013-03* FX 82-51-7016-03* FX 82-51-1012-03* FX 82-51-0014-03* FX 82-51-2013-03* FX 82-51-3016-03*
	 FX 005S	4-5/16" x 25.5' 2 Packs	FX 53000-6TX FX 53001-6TX FX 53013-6TX		D0129ZU D0129ZT D0129ZV D0129ZW		
Various Models	 FX 006S	5-31/32" x 103'	FX G-102-BP FX J-105-AB	Please call us for your specific application.			
30, 40	 FX 012C	11-1/8"	FX 898074** FX 898023** FX 898413** FX 899413**	 MP 012P	L0121CJ L0121CN L0121CQ	Red Black Blue	MP 82-39-0202-06* MP 82-39-0101-06* MP 82-39-0203-06*
	 FX 010C FX 008C	8-7/8" 7"	FX 799413 FX 69865	 MP 015P	C0149NP C0149NS C0149PW	Blue Black Red	MP 82-60-0013-06 MP 82-60-0031-06 MP 82-60-0022-06
740	 FX 012C	11-1/8"	FX 899413** FX 898074** FX 898413**	 MP 012P	L0122AR L0122DB L0122CG L0122BP	Red Blue Green Purple	MP 82-39-0102-06* MP 82-39-0403-01* MP 82-39-0304-01* MP 82-39-0206-01*
751R/762R	 CLH 001S	120mm x 105'	CLH GD200218	 CLH 026P	L0122JU L0122JW L0122JY L0122KF	Red Blue Green Purple	CLH 82-82-0202-01 CLH 82-82-0103-01 CLH 82-82-0304-01 CLH 82-82-0406-01
	 CLH 002S	120mm x 105'	CLH GD201123				
761R	 CHO 006C	114mm x 33"	CHO L0120NP	 CHO 001P/002P	L0120NS L0120NT L0120NR L0120NQ	Red Green Blue Black	CHO64-48-0022-03 CHO64-48-0024-03 CHO64-48-0023-03 CHO64-48-0011-05

















* See Accessories Section for pen arms to fit these pens and your recorder.















** For 7 pt. paper, add a "L" to the Order by Number.















New products are added every day. If the charts or disposable pens that you need are not listed, please call us.















Instrument/Model No.(s) To Fit:	Chart			Our Matching Pen or Ribbon				
	Format	Size	Order By Number	Key	P/N	Color	Order By Number	
Foxboro (Continued) 4060	 FX 007S	200mm x 68'	FX E906ANF FX XT-127	 YOK 010P  Violet: YOK 009P	B9565AP B9565AQ B9565AR Plotter Pen B9565AS	Red Green Blue Violet	YOK 82-24-0302-03 YOK 82-24-0204-03 YOK 82-24-0103-03 YOK 82-24-0406-03	
4110 (Chino AA)	 FX 013S	318mm x 66'	FX A2052TB	N/A				
Fuji Electric PGN, PGV & PHP	 FJE 003S	230mm x 55' 115.5mm x 51'	FJE NL-1000-S FJE FL-5000-S	Please call us for your specific application.				
Microjet PHA7, PHA8, PHA9, PHB	 FJE 001S	200mm x 66' Ink Jet Paper	FJE BL-1000-B	 FJE 001	PHZ H1001	Multi	FJE PHZ H1001	
Microjet PHC3, PHC6, PHC7, PHD	 FJE 002S	113mm x 49.5' Ink Jet Paper	FJE DL-5000-B					
Furuno F-850 Series	 FNO 008S	202mm x 66' No Range	FNO KP-108 (PD 2020)		No Pen/Ribbon Required			
F-850A		202mm x 66' 0-130/0-260 Fathoms	FNO KP-108L (PD 2020LA)					FNO KP-108L-Feet
								FNO KP-108LY (PD 2020LB)
F-860 Series	151mm x 82' No Range	FNO KP-106B (PD 1525)	FNO KP-108Y					















Instrument/Model No.(s) To Fit:	Chart			Our Matching Pen or Ribbon			
	Format	Size	Order By Number	Key	P/N	Color	Order By Number
Furuno (Continued) F-860F	 FNO 006S	147mm x 33' 0-180/135-315 Feet	FNO KP-106Y (PD 1510B)		No Pen/Ribbon Required		
		147mm x 33' No Range	FNO KP-106 (PD 1510)				
F-861A	 FNO 009S	151mm x 82' 0-130/0-260 Fathoms	FNO KP-106A (PD 1525LA)				
FG 11A	 FNO 009S	99mm x 50' No Range	FNO KP-104 (PD 1015)				
FG 11F	 FNO 004S	99mm x 50' 0-480 Feet	FNO KP-104L (PD 1015L)				
			FNO P-10				
200	 FNO 004S	99mm x 50' No Range	FNO KP-104 (PD 1015)				
200B	 FNO 004S	99mm x 50' 0-480 Feet	FNO KP-104L (PD 1015L)				
Various Models	 FNO 002S	14-5/16" x 197' No Range	FNO AP-1460	Metallized No Pen/Ribbon Required			
	 FNO 0304S	111mm x 131' No Range	FNO TP-0340		Black Image No Pen/Ribbon Required		
General Electric CF Series	 GE 004S	4" x 66' or 72'	GE V1A3-1	-	4141571P2	Typewriter Ribbon	
CD, CDP	 GE 005S	4-3/8" x 66' or 72'	GE L1A3-1				











Instrument/Model No.(s) To Fit:	Chart			Our Matching Pen or Ribbon			
	Format	Size	Order By Number	Key	P/N	Color	Order By Number
General Electric (Continued) CH 1, 2, 3, 4, 6, 7, 11, 39	 GE 007S	5-31/32" x 110' or 112'	GE A1A1-2	 GE 002P	2366K11700 4496K10701	Red	GE 82-74-1002-02
CH-37, CD-37, Duplex	 GE 010S	10" x 60'	GE H4E5-H4D2	 GE 003P	2366K11700 4496K10701	Red	GE 82-74-2002-02
	 GE 009S	10" x 120'	GE 785A-786A				
DG Demand Meter	 GE 006S	5-31/32" x 66' or 72'	GE 6905A	N/A			
Gilford Various Models	 PNR 157S	2-1/4" x 80'	GD 15830 or PNR NO 157		Blue Image No Pen/Ribbon Required		
	 PNR 158S		GD 15830 Black or PNR NO 158		Black Image No Pen/Ribbon Required		
Gould/Brush BI/Rd	 BSH 509S	3.468" x 150'	BSH RA-2922-20		No Pen/Ribbon Required		
EasyGraf™, WindoGraf®	 BSH 327S	120mm x 148'	BSH CL-213688 (AR-100)				
Mark II	 BSH 521S	3.72" x 150'	BSH RA-2922-22				
MK 200A	 BSH 116S	15" x 575' Semi-Perf, w/Annot Stripe	BSH 11-2987-601	—	High Contrast Ink Forced Fluid Ink		





Instrument/Model No.(s) To Fit:	Chart			Our Matching Pen or Ribbon			
	Format	Size	Order By Number	Key	P/N	Color	Order By Number
Gould/Brush (Continued) OEM Mod.	 BSH 076S	5" x 150'	BSH 11-2923-23	–		High Contrast Ink Forced Fluid Ink	
OPS	 BSH 532S	3.72" x 150'	BSH RA-3903-20			No Pen/Ribbon Required	
RS 3200	 BSH 318S	5.2" x 350'	BSH 11-2925-35			Black Image No Pen/Ribbon Required	
	 BSH 325S	130mm x 246'	BSH 11-2925-504				
	 BSH 122S	5.2" x 275' w/Annot Stripe	BSH 11-2917-30	–		High Contrast Ink Forced Fluid Ink	
RS 3400	 BSH 310S	9.84" x 246'	BSH 11-2945-503			Black Image No Pen/Ribbon Required	
	 BSH 308S	9.84" x 350'	BSH 11-2945-32				
	 BSH 123S	9.84" x 275' High Contrast Ink, w/Annot Stripe	BSH 11-2947-31	–		Forced Fluid Ink	
RS 3600	 BSH 304S	15" x 350'	BSH 11-2965-33			Black Image No Pen/Ribbon Required	
	 BSH 321S	15" x 246'	BSH 11-2965-504				
	 BSH 115S	15" x 275' Semi-Perf w/Annot Stripe	BSH 11-2967-301	–		High Contrast Ink Forced Fluid Ink	





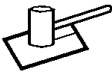





Instrument/Model No.(s) To Fit:	Chart			Our Matching Pen or Ribbon			
	Format	Size	Order By Number	Key	P/N	Color	Order By Number
Gould/Brush (Continued) RS 3800	 BSH 319S	15" x 246'	BSH 11-2985-503			Black Image No Pen/Ribbon Required	
	 BSH 304S	15" x 150'	BSH 11-2985-38				
	 BSH 115S	15" x 275' Semi-Perf w/Annot Stripe	BSH 11-2987-302	-		High Contrast Ink Forced Fluid Ink	
TA 600	 BSH 306S	6" x 250'	BSH 11-6905-301			Blue Image No Pen/Ribbon Required	
	 BSH 307S	6" x 300' No Grid	BSH 11-6905-31				
TA 2000	 BSH 338S	8-15/32" x 325'	BSH CL-211097			No Pen/Ribbon Required	
TA 4000, TA 6000	 BSH 337S	384mm x 328'	BSH 23-5215-10				
	 BSH 346S	384mm x 354'	BSH 23-5215-11				
100, 110	 BSH 328S	11" x 120'	BSH 11-2915-10 BSH 11-2915-11			Blue Image No Pen/Ribbon Required	
200	 BSH 087S	15" x 500' Semi-Perf	BSH 11-2983-504	-		High Contrast Ink Forced Fluid Ink	
220/222	 BSH 341S	4.285" x 275'	BSH 11-2925-30			Blue Image No Pen/Ribbon Required	

Instrument/Model No.(s) To Fit:	Chart			Our Matching Pen or Ribbon			
	Format	Size	Order By Number	Key	P/N	Color	Order By Number
Gould/Brush (Continued)	 BSH 043S	4.285" x 275'	BSH 11-2923-32	 BSH 002P	11-2823-33 11-2730-01	Black	BSH 82-39-0171-06
240/440	 BSH 048S	7.9" x 275'	BSH 2200-2923-30	–	High Contrast Forced Fluid Ink		
250	 BSH 038S	6" x 100'	BSH 11-2913-10				
260	 BSH 078S	12.52" x 225' Semi-Perf	BSH 11-2963-200				
280	 BSH 028S	7.9" x 275'	BSH 11-2923-20				
480	 BSH 071S	15" x 300' Semi-Perf	BSH 11-2983-300				
	 BSH 301S	15" x 300'	BSH 11-2985-33		Blue Image No Pen/Ribbon Required		
2100	 BSH 929S	2.47" x 150'	BSH 11-2915-20		Blue Image No Pen/Ribbon Required		
	 BSH 002S	2.47" x 150'	BSH 11-2913-22	–	High Contrast Forced Fluid Ink		
2200	 BSH 305S	5.2" x 275'	BSH 11-2925-33		Blue Image No Pen/Ribbon Required		
	 BSH 052S	5.2" x 275'	BSH 11-2923-35	–	High Contrast Forced Fluid Ink		











Instrument/Model No.(s) To Fit:	Chart			Our Matching Pen or Ribbon			
	Format	Size	Order By Number	Key	P/N	Color	Order By Number
Gould/Brush (Continued) 2400	 BSH 064S	9.84" x 275'	BSH 11-2923-34	—		High Contrast Forced Fluid Ink	
	 BSH 309S	9.84" x 275'	BSH 11-2945-31			Black Image No Pen/Ribbon Required	
2600	 BSH 069S	15" x 275' Semi-Perf	BSH 11-2963-300	—		High Contrast Forced Fluid Ink	
	 BSH 335S	15" x 275' Semi-Perf	BSH 11-2965-300			Blue Image No Pen/Ribbon Required	
2800	 BSH 301S	15" x 275'	BSH 11-2985-32			Black Image No Pen/Ribbon Required	
	 BSH 319S	15" x 492'	BSH 11-2985-501				
	 BSH 072S	15" x 275' Semi-Perf	BSH 11-2983-301	—		High Contrast Forced Fluid Ink	
8000S	 BSH 332S	66mm x 198' 1 Channel	BSH X72411			Blue Image No Pen/Ribbon Required	
	 BSH 334S	126mm x 198' 2 Channel	BSH X72421				
	 BSH 336S	249mm x 198' 4 Channel	BSH X72441				
	 BSH 080S	377mm x 198' 6 Channel	BSH X72461				
377mm x 198' 8 Channel		BSH X72481					





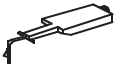









Instrument/Model No.(s) To Fit:	Chart			Our Matching Pen or Ribbon			
	Format	Size	Order By Number	Key	P/N	Color	Order By Number
Graphtec (Western Graphtec, Inc.) MA6000, WR7700, WR8000, WR9000	 WAT 330S	210mm x 132'	WAT PR-231		Black Image No Pen/Ribbon Required		
		210mm x 120' with cross perf	WAT PRZ 231				
	 WAT 329S	210mm x 328'	WAT PZ-231				
Mark 10-1, WR3600	 WAT 327S	389mm x 328'	WAT PR-360-B				
	 WAT 338S WAT 339S	389mm x 328' 389mm x 656'	WAT PZ-360-B WAT PZ-361-B				
Mark 12, DMS100	 WAT 327S	389mm x 328'	WAT PR-360-B				
	 WAT 338S WAT 018S	389mm x 328' 389mm x 656'	WAT PZ-1000 WAT PZ-2000				
MC5500, MC6700, MC6800, SR6200, SR6211, SR6335, SR6340-2	 WAT 011S	280mm x 66'	WAT SP-216B	Call us for your specific application.			
	 WAT 010S	277mm x 50'	WAT PZ-211 (WAT SP-242)				
MC-6620	 WAT 005S WAT 004S	282mm x 50' 114mm x 32'	WAT PZ-260 WAT SP-310				











Instrument/Model No.(s) To Fit:	Chart			Our Matching Pen or Ribbon			
	Format	Size	Order By Number	Key	P/N	Color	Order By Number
Graphtec (Continued) SR6402, SR6411, SR6421	 WAT 002S	50mm x 132'	WAT SP-267				
WR3101, WR3500, WR3710	 WAT 318S	116mm x 100M	WAT PR-420-1B				No Pen/Ribbon Required
	WAT 308S	206mm x 100M	WAT PR-422-2B		1-80mm Channel Black Image		
	WAT 304S WAT 303S WAT 314S WAT 318S	116mm x 100M 116mm x 100M 115mm x 100M 115mm x 100M	WAT PR-410-2B WAT PR-410-2H WAT PR-468-2H WAT PR-468-2B		2-80mm Channels Black Image		
	WAT 307S	206mm x 100M 206mm x 328' 206mm x 328'	WAT PR-412-4H WAT PR-457-4B WAT PR-457-4H		2-40mm Channels Black Image Blue Image Blue Image Black Image		
	WAT 308S	206mm x 100M	WAT PR-412-4B		4-40mm Channels Blue Image Black Image Blue Image		
	WAT 320S	386mm x 100M	WAT PR-424-4B		Black Image		
	WAT 311S	296mm x 100M 296mm x 100M 386mm x 100M 386mm x 100M	WAT PR-413-6B WAT PR-413-6H WAT PR-462-6B WAT PR-462-6H		4-80 Channels Black Image		
	WAT 321S	566mm x 100M	WAT PR-426-6B		6-40mm Channels Black Image Blue Image Black Image Blue Image		
	WAT 314S	384mm x 328' 286mm x 100M 286mm x 100M 386mm x 100M	WAT PR-384-8B WAT PR-414-8B WAT PR-414-8H WAT PR-458-8B		6-80mm Channels Black Image		
	 WAT 303S WAT 305S	116MM X 100M 116mm x 100M	WAT PZ-410-2H WAT PZ-410-2B		8-40mm Channels Black Image Black Image Blue Image Black Image		
	WAT 319S	206mm x 100M	WAT PZ-422-2B		No Pen/Ribbon Required		
	WAT 307S	206mm x 100M	WAT PZ-412-4H		2-40mm Channels Blue Image Black Image		
					2-80mm Channels Black Image		
					4-40mm Channels Blue Image		















Instrument/Model No.(s) To Fit:	Chart			Our Matching Pen or Ribbon					
	Format	Size	Order By Number	Key	P/N	Color	Order By Number		
Graphtec (Continued) WR3101, WR3500, WR3710 (Continued)	 WAT 319S WAT 322S	205mm x 100M	WAT PZ-457-4B		No Pen/Ribbon Required				
		206mm x 100M	WAT PZ-412-4B		Black Image Black Image				
	WAT 311S	296mm x 100M	WAT PZ-413-6B WAT PZ-413-6H		6-40mm Channels Black Image Blue Image				
WAT 313S WAT 314S	386mm x 100M 386mm x 100M	WAT PZ-458-8H WAT PZ-414-8B WAT PZ-414-8H WAT PZ-458-8B	8-40mm Channels Blue Image Black Image Blue Image Black Image						
WR 5020	 WAT 338S	389mm x 328'	WAT PZ-363-B		Black Image No Pen/Ribbon Required				
WR-7500-2	 WAT 306S WAT 017S	4-1/8" x 130' 4-1/8" x 492'	WAT PZ-220 WAT PZ-221						
	 WAT 306S	4-1/8" x 130'	WAT PR-220						
WR-7600	 WAT 323S	4-21/64" x 130'	WAT PR-230						
WX2400, WX4401-3	 WAT 008S	210mm x 66'	WAT SP-279	Call us for your specific application.					
—	 WAT 108S	200mm x 66'	WAT PZ-320						
Grason-Stadler Flatbed Recorders	 GSI 008R	5" x 8" 500 Sheets	GSI 1703-9105	 MP 004P				—	Red Blue Green















Gulfton — See dataGRAPHIC® section, pg. 100











Instrument/Model No.(s) To Fit:	Chart			Our Matching Pen or Ribbon			
	Format	Size	Order By Number	Key	P/N	Color	Order By Number
Hagan/Westinghouse/ C.C.D./Rosemount Ring Balance 2000, 3000, 4000, 5000, 6000 (12")	 RG 012C	11-7/8"	RG 88-1100-100	 MP 012P	–	Black	MP 82-39-0101-06
				 MP 011P	1948561A1 1948561A2 1948561A3 1948561A4	#1 Red #2 Blue #3 Green #4 Purple	MP 82-76-1002-03 MP 82-76-2003-03 MP 82-76-3004-03 MP 82-76-4006-03
100, 300 Optimac	 RG 004S	4-15/32" x 65'	RG 174567-0010001	 WE 035P Steel Stylus Pen	173680	Without Scales	
					173681	Red	WE 80-22-0152-01A
					173682	Green	WE 80-22-0164-01A
					173682	Blue	WE 80-22-0173-01A
				175290	With Scales		
				175291	Red	WE 80-22-1192-01A	
175291	Green	WE 80-22-1204-01A					
175292	Blue	WE 80-22-1213-01A					
				 MP 021P 2.6cc	170085-1 170085-2 170085-3 170085-4	Red Blue Green Purple	MP 81-10-0012-04A MP 81-10-0013-04A MP 81-10-0014-04A MP 81-10-0016-04A
					 WE 056P	540996 – 540998	Disposable Pen
						Red	WE 82-55-0102-03
						Blue	WE 82-55-0303-03
						Green	WE 82-55-0204-03
Hays/Republic EFG, EFR, 662 (Formerly "C"), 771	 HRP 012C	11-7/8"	HRP H7 series HRP 11-Series HRP 12-Series	 MP 012P	Universal Series 39 Pens	Black	MP 82-39-0201-06
						Red	MP 82-39-0212-06
						Blue	MP 82-39-0103-06
1520 (Old Type Model 2400 Bowtie)	 HRP 012C	11-7/8"	HRP 14-Series HRP 15-Series HRP 16-Series			Green	MP 82-39-0304-06
1520 (Model 2100 Round Center Hole)	 HRP 012C	11-7/8"	HRP 17-, 21-, 24-, 458-, 1225-, 7000- Series			<i>See our Universal Series 39 Pen section, pg. 128, for a complete listing of pen colors and nib lengths.</i>	













Instrument/Model No.(s) To Fit:	Chart			Our Matching Pen or Ribbon			
	Format	Size	Order By Number	Key	P/N	Color	Order By Number
Hays/Republic (Continued) 221	 HRP 010C	9-15/16" to 10-3/32"	HRP CH Series HRP T Series HRP 3-Series HRP 6-Series, HRP 60, 61, 62, 63, 67, 68, 70, 300, 400, 500, 6200, 10000 Series	 MP 012P	Universal Series 39 Pens	Black Red Blue	MP 82-39-0201-06 MP 82-39-0212-06 MP 82-39-0103-06 <i>See our Universal Series 39 Pen section, pg. 128, for a complete listing of pen colors and nib lengths.</i>
Hewlett-Packard Gas Chromatograph	 HP 022S	9-1/2" x 2292'	HP 5062-3561		N/A		
PC 150, 125, 2673 2674A	 HP 328S	8-1/2" x 100'	HP 92160A		Blue Image No Pen/Ribbon Required		
	 HP 341S		HP 92160B				
	 HP 340S		HP 92160C				
Thinkjet	 HP 022S	9-1/2" x 2292'	HP 92261N	 HP 015P	92261A	HP 92261A	
97A, 3075A, 3076A, 3077A	 HP 304S	2-1/4" x 80'	HP 82045A		Blue Image No Pen/Ribbon Required		
	 HP 352S		HP 82175A				
12966A, 13246A	 HP 310S	8-3/4" x 250'	HP 9270-0488		Black Image No Pen/Ribbon Required		
1040A HPLC, 3390, 3392, 3393, 5080-8800-1, 5080-8800-2	 HP 036S	107mm x 400'	HP 82931A		Blue Image No Pen/Ribbon Required		
			HP 82954A		Black Image No Pen/Ribbon Required		

Instrument/Model No.(s) To Fit:	Chart			Our Matching Pen or Ribbon				
	Format	Size	Order By Number	Key	P/N	Color	Order By Number	
Hewlett-Packard (Continued) 1080	 HP 331S	8-1/2" x 184'	HP 5080-8735 BLACK			Black Image No Pen/Ribbon Required		
	 HP 007S		HP 5080-8735 BLUE					Blue Image No Pen/Ribbon Required
2671A, 2671G	 HP 328S	8-1/2" x 100'	HP 92160A			Blue Image No Pen/Ribbon Required		
	 HP 341S		HP 92160B					Black Image No Pen/Ribbon Required
	 HP 340S		HP 92160C					
	 HP 338S	8-1/2" x 302'	HP 92160M			Blue Image No Pen/Ribbon Required		
	 HP 337S		HP 92160N					Black Image No Pen/Ribbon Required
	2673A	 HP 338S	8-1/2" x 302'	HP 92160M			Blue Image No Pen/Ribbon Required	
 HP 337S		HP 92160N		Black Image No Pen/Ribbon Required				
3054DL	 HP 036S	107mm x 400'	HP 9270-0962			Blue Image No Pen/Ribbon Required		

Instrument/Model No.(s) To Fit:	Chart			Our Matching Pen or Ribbon				
	Format	Size	Order By Number	Key	P/N	Color	Order By Number	
Hewlett-Packard (Continued) 3380A, 3380S, 3385A, 5830A, 5840A	 HP 331S	8-1/2" x 184'	HP 5080-8735 BLACK			Black Image No Pen/Ribbon Required		
	 HP 007S		HP 5080-8735 BLUE					Blue Image No Pen/Ribbon Required
3388	 HP 007S	8-1/2" x 184'	HP 5080-8735 BLUE			Blue Image No Pen/Ribbon Required		
	 HP 378S		HP 9270-0625					Black Image No Pen/Ribbon Required
3396A	 HP 090S	9-1/2" x 272'	HP 5181-1219			-		
520, 9000, 9876A	 HP 047S	8-1/2" x 302'	HP 9270-0640			Black Image No Pen/Ribbon Required		
5880	 HP 331S	8-1/2" x 184'	HP 5080-8735 BLACK			Black Image No Pen/Ribbon Required		
	 HP 007S		HP 5080-8735 BLUE					Blue Image No Pen/Ribbon Required
	 HP 378S		HP 9270-0625					Black Image No Pen/Ribbon Required
5880A	 HP 319S	8-1/2" x 184'	HP 9270-0625 BLUE			Blue Image No Pen/Ribbon Required		
	 HP 378S		HP 9270-0625					Black Image No Pen/Ribbon Required

Instrument/Model No.(s) To Fit:	Chart			Our Matching Pen or Ribbon			
	Format	Size	Order By Number	Key	P/N	Color	Order By Number
Hewlett-Packard (Continued) 680, 7143A	 HP 006S	6" x 100'	HP 9270-1012 HP 9270-1025	 HP 002P	07143-6000	Black Red Blue	HP 82-41-0011-03 HP 82-41-0012-03 HP 82-41-0013-03
7100B, 7101B, 7127A, 7128A	 HP 010S	11" x 120'	HP 9270-1010 HP 9270-1072 HP 9280-0131	N/A			
	 HP 034S	279mm x 120'	HP 9270-1037				
7123	 HP 010S	11" x 100'	HP 9280-0222				
7123A	 HP 010S	6" x 100'	HP 9280-0175	 HP 002P	07143-6000	Black Red Blue	HP 82-41-0011-03 HP 82-41-0012-03 HP 82-41-0013-03
			HP 9280-0176				Black Red
7130A, 7130B, 7131A 7131B, 7132A, 7133A	 HP 011S	11" x 100'	HP 9280-0264 HP 9280-0265	 HP 004P	07130-62510 07130-62500	Red Blue	HP 82-40-0012-03 HP 82-40-0013-03
7310A	 HP 313S	210mm x 246' 8-1/2" x 246'	HP 9270-0680 HP 9270-0682			Black Image Blue Image No Pen/Ribbon Required	
	 HP 314S		HP 9270-0681 HP 9270-0683				
7702B	 HP 025S	125mm x 200'	HP 651-52				
7708B	 HP 020S	400mm x 200'	HP 651-58				













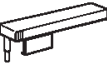

Instrument/Model No.(s) To Fit:	Chart			Our Matching Pen or Ribbon			
	Format	Size	Order By Number	Key	P/N	Color	Order By Number
Hewlett-Packard (Continued) 82143A, 82162A	 HP 304S	2-1/4" x 80'	HP 82045A			Blue Image No Pen/Ribbon Required	
	 HP 352S		HP 82175A				
8451A	 HP 036S	107mm x 400'	HP 82931A HP 82954A			Blue Image Black Image No Pen/Ribbon Required	
9810A, 9820A, 9821A	 HP 039S	2-1/4" x 250'	HP 9281-0401			Blue Image No Pen/Ribbon Required	
9815A, 9815S, 9825A, 9825S, 9835A, 9835B	 HP 359S	2-1/4" x 250'	HP 9270-0664			Black Image No Pen/Ribbon Required	
9830, 9866A, 9866B	 HP 310S	8-3/4" x 250'	HP 9270-0488				
9845A, 9845B, 9845C 9845S, 9845T	 HP 061S	8-31/64" x 200'	HP 9270-0565 (92161D)			Black Image No Pen/Ribbon Required	
	 HP 055S	8-1/2" x 200'	HP 9270-0566 (92161A) HP 92161B			Blue Image No Pen/Ribbon Required	
	 HP 326S	209mm x 197'	HP 9270-0569 (92161M)				
	 HP 342S	8-1/2" x 200' 209mm x 200'	HP 9270-0661 (92161C) HP 9270-0662			Black Image No Pen/Ribbon Required	













Instrument/Model No.(s) To Fit:	Chart			Our Matching Pen or Ribbon			
	Format	Size	Order By Number	Key	P/N	Color	Order By Number
Hitachi D-2000, U-2000	 HIT 011S	277mm x 23.5M	HIT 340-1000	 MP 006P	-	Red Black	MP 82-12-0272-05 MP 82-12-0271-05 5 pens per pack
	 HIT 009S	234mm x 150'	HIT 661-7501			Black Image No Pen/Ribbon Required	
	 HIT 310S	234mm x 165' 180 sheets	HIT 661-7501FF				
	 HIT 003S	108mm - 111.5mm x 19.8M	HIT XE-6001A	Call us for your specific application.			
	 HIT 007S	200mm x 65'	HIT ZV-10000				
56, 165	 PR 013S	276mm x 100'	PR 056-7300 PR 159-1003 PR 165-1003	 MP 006P	-	Black Red	MP 82-12-0271-05 MP 82-12-0272-05 5 pens per pack
Honeywell AR-100, DR 4200 GP/EV	 BN 010C	10-5/16"	BN 24001660-001	 MP 012P	-	Black Red Blue	MP 82-39-0101-06 MP 82-39-0202-06 MP 82-39-0303-06
	 BN 312C	11-7/8"	BN 30755317			Black Image No Pen/Ribbons Required	









What Is the Shelf Life of an Ink Writing Chart?

While there is no universal agreement on the exact shelf life of strip charts used in pen or ribbon-writing applications, tests have been conducted and show that these papers can become brittle and lose their fold strength after as long as 25 years, with no appreciable loss to any other mechanical properties.

Graphic Controls recommends storage in ambient conditions of 72°F and 50% R.H. to maintain the integrity of a chart, from a perspective of cleanliness and dimensional accuracy.

Instrument/Model No.(s) To Fit:	Chart			Our Matching Pen or Ribbon			
	Format	Size	Order By Number	Key	P/N	Color	Order By Number
Honeywell (Continued) DR 4500 Classic; Servoline 1, 2, 3 or 4 Pen; 15, 22, 45, 60, 70	 BN 012C	11-7/8"	BN 12001 BN 680060-48	 MP 012P	—	Black Red Blue Green	MP 82-39-0101-06 MP 82-39-0202-06 MP 82-39-0303-06 MP 82-39-0404-06
	Model 111	 BN 008C	6-7/16"	BN 10-056			
Class 61 (both round rectangular case recorders)			BN 659965-001	 MP 016P	Series 72 Gas Pens	Temperature Red	MP 82-72-3162-06
				 MP 025P	Series 79 Gas Pens	Humidity Purple	MP 82-79-3366-06
	<i>See Accessories section, pg. 93, for Pen Arms to fit these pens and your recorder.</i>						
DPR 100, 1000, 1000B, 1000D, RL100, Miniprint RL	 BN 404S	120mm x 52'	BN 46180522-001 BN 46180582-001	 MP 120P	46180501-001/ 501	6 Color Print Wheel Multi	MP 64-08-200V-01 64-49 Series
	 BN 204S	120mm x 52'	BN 46187	 MP 071P	46180185-001 /501 46180185-002 /502	Red Blue	MP 64-50-0102-01 MP 64-50-0103-01
DPR 3000	 BN 117S	308mm x 115'	BN 46182708-001	 MP 102P	46182712-001	Multi	MP 64-11-110V-01
	 BN 217S	308mm x 115'	BN 46182707-001				
RL, Vutronic 37301, 37302, 37303	 BN 004S	4-11/32' x 54'	BN 659811-023	 BN 004P	30750265-001 30750524-001 3070265-002 3075024-002 30750265-003 30750524-003	Inner Red Middle Blue Outer Green	BN 82-59-4012-06 BN 82-59-5013-06 BN 82-59-6014-06

Instrument/Model No.(s) To Fit:	Chart			Our Matching Pen or Ribbon			
	Format	Size	Order By Number	Key	P/N	Color	Order By Number
Honeywell (Continued) Visicorder Photo Record	 PHS 006S	6" x 100' Pink Standard, 2	PHS G6100		No Pen/Ribbon Required		
		8" x 100' Pink Standard, 2	PHS G8100				
		8" x 200' Pink Extra-Thin, 2	PHS G8200				
	 PHS 008S	8" x 100' Yellow Extra-Thin, 2	BN 16774562-810				
		 PHS 009S	8" x 200' Yellow Extra-Thin, 2				
Vutronic Tel-O-Set	 BN 003S		3-17/64" x 70'	BN 4300-001	 BN 004P	-	Red
Class 15, 16, 153	 BN 012S	12" x 120'	BN 501		30750479-001	#1 Single Red	BN 82-48-2012-03
					30750480-001, 004		
						307540479-002	#1 Inner Purple
30750480-002, 005							
Class 111	 BN 008S	6-19/32" x 127;	BN 100-058	 BN 003P	30733204 (241-001)	Red	BN 82-28-0022-04
					30733204 (241-002)	Purple	BN 82-28-0016-04
Class 112	 BN 009S	6-19/32" x 85'	BN 680032-058		Blue Image No Pen/Ribbons Required		

Instrument/Model No.(s) To Fit:	Chart			Our Matching Pen or Ribbon			
	Format	Size	Order By Number	Key	P/N	Color	Order By Number
Houston Instruments Omniscribe	 HI 010S	11" x 100'	HI ECP-100 HI ECX-100	 HI 004P	YMP-494 YMP-495 YMP-497 YMP-496	Black Red Blue Green	HI 82-16-1121-04 HI 82-16-1122-04 HI 82-16-1123-04 HI 82-16-1124-04
5120-2	 HI 009S	11" x 100'	HI EC-100				
Illinois Tool Circular Recorder	 IST 006C	6-1/2"	IST B-6-195	 MP 012P	Replaces Bulk Ink	Black Red Blue	MP 82-39-0101-06 MP 82-39-0102-06 MP 82-39-0203-06
Inkwriting Strip Recorder	 IST 004S	4-1/2" x 300'	IST B-X1604-12	Please call us for bulk ink.			
Thermal Strip Recorder	 IST 304S	4-1/2" x 300'	IST B-X1604-13		No Pen/Ribbon Required		

Dimensional Stability of Chart Papers











Paper is a hydrophilic material; it can take on or give off moisture continually to remain in equilibrium with its surrounding environment. Paper grows or shrinks whenever moisture levels change in the surrounding atmosphere (relative humidity). A good example of this is the difference between a wet sponge and a dry one. Paper, when viewed under a microscope, acts like a sponge, constantly taking in and giving off moisture. The result in many cases is a dimensionally-
instable material.

Refined or specialty papers can grow or shrink as much as 5% of their total length over a humidity range of 50%. This type of change is intolerable in many industrial measurement applications.

Graphic Controls specifies for use specialty chart papers which have an allowance for growth (referred to as hygroexpansivity) of 0.4% maximum in the machine direction and 1.0% maximum in the cross-machine direction for any change in relative humidity of 50%. This is the best a chart manufacturer can do with regard to stability.



Even this limit tolerates some change. For example: a change in dimensions of 0.0215" to 0.1075" over a 10.75" grid width of a circular chart can occur where humidity changes as much as 50%.



Graphic Controls does have at its disposal other chart media with lower expansivity levels, such as those used in its calibration disc product line; but these are only recommended where the premium can be substantiated in value to the end user.

Instrument/Model No.(s) To Fit:	Chart			Our Matching Pen or Ribbon			
	Format	Size	Order By Number	Key	P/N	Color	Order By Number
Instron Various Models	 INS 009S	280mm x 50'	INS 3710-027 (88-6-17)	 YOK 019P	B9518 CS B9518 CT B9518 CU B9518 CV	Black Red Green Blue	YOK 64-19-0101-03 YOK 64-19-0102-03 YOK 64-19-0104-03 YOK 64-19-0103-03
	 YOK 011S		INS 3710-028 (88-6-16)				
	 INS 012S	11-5/32" x 120'	INS 3710-016 (88-51-10)	 MP 006P	Black Long Red Long	Long Black Red	MP 82-12-0341-05 MP 82-12-0342-05
	 INS 007S	6-49/64" x 120'	INS 3710-022 (88-6-3)				
	 INS 010S	10-11/16" x 120'	INS 103 (3710-003)	 LS 004P	022973	Red	LS 82-43-0012-03
	 INS 001S	11-1/2" x 120'	INS 88-6-1X (3710-014) INS 88-6-2X (3710-015)				
	 INS 011R	11" x 16-1/2" (100/Box)	INS 3710-018 (86-6-18)	Please call us for your specific application.			







IRD Mechanalysis — See dataGRAPHIC® Section, pg. 101

ITT Barton — See our Gas Measurement Catalog for details.









Kaye Instrument Digistrip I	 KI 009S	9-7/8" x 75'	KI Digistrip		Blue-Black Image No Pen/Ribbon Required		
	Digistrip II, Digistrip III	 KI 012S	12" x 106'		KI M0775	Black Image No Pen/Ribbon Required	

















Instrument/Model No.(s) To Fit:	Chart			Our Matching Pen or Ribbon			
	Format	Size	Order By Number	Key	P/N	Color	Order By Number
Kaye Instrument (Continued) Digistrip II, Digistrip III (Continued)	 KI 301S	11" x 215'	KI M0780			Black Image No Pen/Ribbon Required	













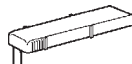



Kent — See ABB Instrumentation, pg. 8











Kipp & Zonen BD 40/41, BD 111/112	 KZ 009S	230mm x 82'	KZ XR-9	 KZ 002P	2643-908 2643-909 2643-911 2643-910 -	Black Red Blue Green Red	KZ 82-68-0101-06 KZ 82-68-0102-06 KZ 82-68-0103-06 KZ 82-68-0104-06 KZ 82-68-0202-06
BD 100/101	 KZ 010S  KZ 011S	269mm x 66'	KZ XR-51 KZ XR-23				
BD 60/61	 KZ 309S	9-1/32" x 150'	KZ 495R 6500 (XR-33)			Black Image No Pen/Ribbon Required	









Konel-Furuno — See Furuno, pg. 30

Leeds & Northrup LN 200	 LS 007C	10-3/4"	LS 290001	 KPC 095P	075800 075801 075802	Middle Red Inner Green Outer Blue	KPC 82-95-2012-05A KPC 82-95-1014-05A KPC 82-95-3013-05A
Speedomax G Micromax	 LS 010S	10-11/16" x 120'	LS 690001	 LS 004P	022973	Red	LS 82-43-0012-03
Speedomax G Micromax R	 LS 010S	10-3/8"	LS 590001	 MP 012P	-	Red	MP 82-39-0202-06
Speedomax H Model "S"	 LS 007S	7-3/16" x 84'	LS 660001	 MP 198P	054366	Before 1968 - .220" nib Red	LS 82-12-0372-05A <i>See Accessories section, pg. 94, for pen holder 80-36-0480-01.</i>

Instrument/Model No.(s) To Fit:	Chart			Key	Our Matching Pen or Ribbon		
	Format	Size	Order By Number		P/N	Color	Order By Number
Leeds & Northrup (Continued) Speedomax H Model "S" (Continued)	 LS 008C	8"	LS 620001	 LS 002P	024176 05440	Red	LS 82-42-0012-03
Speedomax W	 LS 009S	10-11/16" x 90'	LS 490001	 LS 006P	054190 054191 054192	After 1968 - .370" nib Red Blue Black	LS 82-27-0012-05A LS 82-27-0013-05A LS 82-27-0011-05A
Speedomax WL	 LS 009S	10-11/16" x 90'	LS 490001	 LS 036P	030872 030873	Long Red Short Blue	LS 82-54-0012-03 LS 82-54-1013-03
Speedomax 1000 M Series	 LS 004S	4-17/32" x 64'	LS 560006	 LS 035P	M-Mark 025274	Red	LS 82-44-0042-03A
				 LS 040P	M-Mark II 025890 025891 025892 025893	Single Pen - .354" nib Red Multi Pen - .332" nib Red 1.032" nib Blue 1.753" nib Green	LS 82-64-4002-03 LS 82-64-3002-03 LS 82-64-2003-03 LS 82-64-1004-03
				 LS 035P	M-Mark III 025240 025242 025243	Medium Blue Long Green Short Red	LS 82-44-0023-03A LS 82-44-0014-03A LS 82-44-0032-03A
Speedomax 1000 100 Series	 LS 002S	110mm x 54'	LS 537104	 LS 005P	041392 041393 041394	Inner - .15" nib Red Middle - .62" nib Blue Outer - 1.10" nib Green	LS 82-80-3002-03 LS 82-80-2003-03 LS 82-80-1004-03
Speedomax 1000 400/430 Series	 LS 002S	110mm x 54'	LS 537104	 LS 060P	018500 018501 018502	#1 Red #2 Blue #3 Green	LS 64-07-1002-03 LS 64-07-2003-03 LS 64-07-3004-03
Speedomax 1000 SPX 1000	 CLH 002S	120mm x 105'	CLH GD201090	 CLH 026P	080600 080601 080602 080603	Blue Red Green Purple	CLH 82-82-0103-01 CLH 82-82-0202-01 CLH 82-82-0304-01 CLH 82-82-0406-01

Instrument/Model No.(s) To Fit:	Chart			Our Matching Pen or Ribbon			
	Format	Size	Order By Number	Key	P/N	Color	Order By Number
Leeds & Northrup (Continued) Speedomax 1000 SPX 1000 (Continued)	 CLH 001S	120mm x 52'	CLH GD201091	 CLH 010P	080604	Multi	CLH 64-11-600V-01
Speedomax SPX 210	 LS 009C	10"	LS 291005	 MP 203P	0801358 0801359 0801360 0801361	Blue Red Green Black	MP 82-88-0103-05 MP 82-88-0202-05 MP 82-88-0304-05 MP 82-88-0401-05
Speedomax XL 600, 620, 625, 630	 LS 009S	10-11/16" x 90'	LS 490001	 LS 026P	054453	Long Red	LS 82-26-0012-05A
Speedomax 165/1650	 LS 016S	8-21/32" x 120'	LS 544001	 LS 003P	020723 (063996) 020724 (063997)	Long Red Short Blue	LS 82-66-1002-03 LS 82-66-2003-03
	 LS 313S		LS 543001		Blue Image No Pen/Ribbon Required		
Speedomax 250/2500	 LS 016S	12" x 120'	LS 546001	 LS 003P	020723 (063996) 020724 (063997)	Long Red Short Blue	LS 82-66-1002-03 LS 82-66-2003-03
	 LS 013S		LS 545001		Blue Image No Pen/Ribbon Required		
Speedomax 24000, 25000	 LS 014S	348mm x 82'	LS 677001	 LS 012P	078913	Multi	LS 078913
Ink for Ink Pads	-	-	-	 LS 020P	125015 125016 125017 125018 125020 125021 125022	1/2 oz. Blue Green Orange Red Tan Black Brown	LS 71-05-1683-01 LS 71-05-1684-01 LS 71-05-1687-01 LS 71-05-1682-01 LS 71-05-168T-01 LS 71-05-1681-01 LS 71-05-1688-01
Ink Pads	-	-	-	 LS 010P	125028 125048	Blue Black	LS 84-01-0033-04 LS 84-01-0031-04

Instrument/Model No.(s) To Fit:	Chart			Our Matching Pen or Ribbon			
	Format	Size	Order By Number	Key	P/N	Color	Order By Number
Leeds & Northrup (Continued) Ink Pads (Continued)	-	-	-	 LS 084P	125030	Red	LS 84-01-0022-12
					125031	Green	LS 84-01-0024-12
125032	Blue	LS 84-01-0023-12					
125033	Black	LS 84-01-0021-12					
125035	Violet	LS 84-01-0026-12					
125036	Brown	LS 84-01-0028-12					
125041	No Ink	LS 84-01-0020-12					
				 LS 084P	125163	Blue	LS 84-01-0163-04
Pad Wheels	-	-	-	 LS 010P	125155	Mix	LS 84-02-011M-01
					125156	Mix	LS 84-02-012M-01
					125157	Mix	LS 84-02-013M-01
					125158	Mix	LS 84-02-014M-01
Leupold & Stevens Drum Recorders	 LD 001R	12-25/32" x 19-1/8"	LD L-2	Please call us for bulk refill ink.			
	 LD 002R	10-3/8" x 12-21/32"	LD F-1				
Narrow Strip Recorders	 LD 004S	4-7/32" x 50'	LD TF-235	 MP 006P	Replaces Bulk Ink	Black	MP 82-12-0471-05
Medium Strip Recorders	 LD 010S	10-3/4" x 75'	LD A-10 LD A-10S LD A-25			Red	MP 82-12-0972-05
Wide Strip Recorders	 LD 020S	20-13/16" x 75'	LD A-20				
Lincoln Meter CCV, CCVAC, CCW, CCA	 LCN 007C	8"	LCN DE Series 800W, V, A Series 8000 W & A Series	 MP 015P	-		MP 82-60-0011-06 MP 82-60-0012-06 MP 82-60-0013-06 MP 82-60-0014-06















Instrument/Model No.(s) To Fit:	Chart			Our Matching Pen or Ribbon			
	Format	Size	Order By Number	Key	P/N	Color	Order By Number
Linear Instruments 4101-4206	 LNR 003S	120mm x 27'	LNR 0100-0032	 LNR 002P	Universal Series 09 Pens	Black	LNR 82-09-0131-05C
						Red	LNR 82-09-0132-05C
140, 141, 142, 143, 1101, 1110	 LNR 004S	120mm x 100'	LNR 0100-0011	 MP 006P	Universal Series 12 Pens	<i>See Universal Series 12 Pens, pg. 126.</i>	
	 LNR 005S	120mm x 52'	LNR 0100-0028				
155, 156	 LNR 006S	162mm x 100'	LNR 0100-0001 (54-100) LNR 0100-0017				
1200, 1201, 1202, 1210	 LNR 009S	230mm x 83'	LNR 0100-0026				
	 LNR 010S	230mm x 100'	LNR 0100-0027				
250, 254, 255, 261, 285, 291, 361, 391, 400, 456, 486, 555, 561, 585, 591, 595, 1800, 1801, 1802, 252, 282	 LNR 011S	280mm x 100'	LNR 0100-0025 LNR 0100-0004 (1010-1) LNR 0100-0013 LNR 0100-0003 (104-100) LNR 0100-0010				













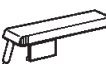

“Feel” of Chart Papers

Charts manufactured by Graphic Controls to fit pen and ribbon writing applications have been engineered for a “different” feel.















Graphic Controls engineers work with the paper mill to develop a chart paper with specific properties to optimize recording ink penetration, pen line quality, fan fold pack squareness, etc.











It’s important to recognize that a smoother sheet does not guarantee a better product in all applications. In pen and ribbon writing charts the trace is harder to read on a smoother sheet due to gloss. A less glossy surface is easier to read at all viewing angles and lessens the risk of inaccurate measurement.

















Instrument/Model No.(s) To Fit:	Chart			Our Matching Pen or Ribbon			
	Format	Size	Order By Number	Key	P/N	Color	Order By Number
Linseis LM, L7600, L7700	 LIN 005S	140mm x 16M	LIN LO/8015-8045 with T2cm or No T5cm timestamping	 LIN 002P	LIN L2001/1	#1 Channel Green	LIN 64-03-1104-05
	 LIN 010S	270mm x 16M	LIN LO/81-84		LIN L2001/2	#2 Channel Red	LIN 64-03-0802-05
LP12, LS4, L4000, L7005, L7105	 LIN 011S	270mm x 25M	LIN LO/8021-8024		LIN L2002/3	#3 Channel Blue	LIN 64-03-0903-05
	 LIN 010S	270mm x 16M	LIN LO/8011-8014		LIN L2001/4	#4 Channel Brown	LIN 64-03-0708-05
LP12, SL4, L4000, L7005, L7105	 LIN 010S	270mm x 16M	LIN LO/8011-8014		LIN L2001/5	#5 Channel Black	LIN 64-03-1001-05
	 LIN 011S	270mm x 25M	LIN LO/8021-8024		LIN L2001/6	#6 Channel Purple	LIN 64-03-1206-05
LS51, LS52, LS6510	 LIN 010S	270mm x 16M	LIN LO81-84	5 pens per pack			
L6010	 LIN 011S	270mm x 25M	LIN LO/8021-8024				
	 LIN 008S	220mm x 16M	LIN LO/8041-8042				
Lowrance LRG 505, LRG 515, LRG 1510, LRG 1520	 LOW 003S	3-63/64" x 50' Lined	LOW 000-0043-00				
	LRG 610A	 LOW 003S	3-63/64" x 50' 0-180' & 0-60 Fathoms	LOW 073-0009-01			
Other Models	 LOW 003S	3-63/64" x 50'	LOW 000-043-01				
	 LOW 002S	3-15/16" x 50'	LOW 000-043-06 LOW 073-0021-01				



















Instrument/Model No.(s) To Fit:	Chart			Our Matching Pen or Ribbon			
	Format	Size	Order By Number	Key	P/N	Color	Order By Number
Marshalltown Instruments [Motoco] 1000	 MO 008C	6"	MO 500 Series, 7-500 Series	 MP 012P	Universal Series 39 Pen	Black	MP 82-39-0101-06
						Red	MP 82-39-0202-06
2000	 MO 009C	6"	MO 2500 Series, 7-2500 Series		Black Image No Pen/Ribbon Required		
Masoneilan Circular Recorders	 MAN 012C	11-1/8"	MAN 61004-1 MAN N-10010	 MP 012P	Replaces Bulk Ink	Red	MP 82-39-0102-06
						Blue	MP 82-39-0203-06
						Black	MP 82-39-0101-06
Mercury Instrument 700, 900, 1200 Series	 MCI 012C	12"	MCI MI 0-500-12 MCI PV-150-12	 MP 016P	Series 72 Gas Pens		MP 82-72-0161-06
800 Series	 MCI 008C	8"	MCI PVO-300-8 MCI PO-100-8	 MP 025P	Series 79 Gas Pens		MP 82-79-0262-06
							MP 82-79-0364-06
	 MCI 012C	10"	MCI AR Series MCI AR-100				
MFE Corp. 1200 Series	 MFE 304S	4-15/16" x 200'	MFE CP2R (90003153)			Black Image No Pen/Ribbon Required	
1400 Series	 MFE 309S	9-55/64" x 200'	MFE CP4R (90003203)			Blue Image No Pen/Ribbon Required	
Micromeritics Flatbed Recorders	 MIC 008R	8-12" x 11"	MIC 500/42701	 MP 002P	500-30602-00 500-30604-00	Black	MP 82-07-0041-05
						Red	MP 82-07-0042-05















M-Tek — See Molytek











Instrument/Model No.(s) To Fit:	Chart			Our Matching Pen or Ribbon			
	Format	Size	Order By Number	Key	P/N	Color	Order By Number
Molytek (Lab Data Controls) 2700	 MYK 312S	12" x 100'	MYK 414446		Black Image No Pen/Ribbon Required		
Various	 MYK 012S LAB 022S	12" x 100'	MYK 414055 MYK 414056	 MP 006P	412022 412023 412025 412026	Blue Red Blue Red	MP 82-12-0273-05 MP 82-12-0042-05 MP 82-12-0213-05 MP 82-12-0342-05
	 LAB 004S	4-7/8" x 32'	LAB 414057	 MP 004P	412001 412002 412003 412004	Blue Red Black Green	MP 82-09-0203-05 MP 82-09-0202-05 MP 82-09-0201-05 MP 82-09-0204-05
Monsanto 1500 Rheometer	 MON 010S	10-31/32" x 118'	MON AC648	 HI 004P	AC 424 AC 439	Red Black	HI 82-16-1122-04 HI 82-16-1121-04
	 MON 002R	8-1/2" x 11"	MON 1393-R	 HI 002P	AX 102 AX 103 AX 104 AX 105	Black Blue Green Red	HI 82-99-0021-05A HI 82-99-0023-05A HI 82-99-0024-05A HI 82-99-0022-05A
Moore Products 360, 361, 3601, 3611, 5319, 5329, 5339	 ME 004S	4-5/16" x 64'	1072	 ME 003P	14960-26/ 16070-26 14960-27/ 16070-27 14960-28/ 16070-28	Inner Red Middle Blue Outer Green	ME 82-83-0102-02 ME 82-83-0203-02 ME 82-83-0304-02
362 (3" x 6")	 ME 004S	4-5/16" x 64'	Please call us for any chart in this series.	 ME 004P	15747-71/ 16070-71 15747-72/ 16070-72 15747-73/ 16070-73 15747-74/ 16070-74	#1 Red #2 Blue #3 Green #4 Orange	ME 82-93-0102-02 ME 82-93-0203-02 ME 82-93-0304-02 ME 82-93-0407-02
							3 markers per pack
							2 markers per pack















Instrument/Model No.(s) To Fit:	Chart			Our Matching Pen or Ribbon			
	Format	Size	Order By Number	Key	P/N	Color	Order By Number
Moore Products (Continued) 5310, 5318, 5320, 5328, 5330, 5338 (6" x 6")	 ME 004S	4-5/16" x 64'	Please call us for any chart in this series.	 ME 004P	14230-165/ 16070-165 14230-166/ 16070-166 14230-167/ 16070-167	Inner Blue Middle Red Outer Green	ME 82-84-0103-02 ME 82-84-0202-02 ME 82-84-0304-02 2 markers per pack
362 Series, 5300 Series, Older Models				<i>See Accessories section, pg. 94, for cartridges.</i>			
Motorola/Westinghouse/ C.C.D./Rosemont 55RV, 56R Veritak	 MOA 005S	4-15/32" x 48' to 55'	MOA 11C46600A01	 WE 039P	01B46044B01 01B46045B01 01B46046B01	#1 Red #2 Green #3 Blue	WE 82-92-2002-03 WE 82-92-1004-03 WE 82-92-3003-03
				<i>Conversion to Series 92 disposable pens requires use of Pen Arm Adapters, see Accessories section, pg. 94.</i>			
NGI/Norma Goertz Instruments SE 120, 420, 460, 461	 BBC 010S BBC 009S	270mm x 53' 270mm x 106'	BBC 195-5510-E00 (A551) BBC 195-5980-E00 (A598)	 BBC 002P	A536-74 A537-75 A536-76	#1 Red #2 Blue #3 Green	BBC 64-01-0102-03 BBC 64-01-0203-03 BBC 64-01-0304-03
200, 210, 220, 300, 310, 311, 320, 321	 BBC 012S	280mm x 82'	BBC 195-4910-E00 (A491)				
430	 BBC 005S  BBC 005S	139mm x 106' 139mm x 53'	BBC 195-6140-E00 (A614) BBC 195-6160-E00 (A616)	 BBC 002P	A536-74 A537-75 A536-76	#1 Red #2 Blue #3 Green	BBC 64-01-0102-03 BBC 64-01-0203-03 BBC 64-01-0304-03

















Instrument/Model No. (s) To Fit:	Chart			Our Matching Pen or Ribbon			
	Format	Size	Order By Number	Key	P/N	Color	Order By Number
Nippon Denshi Kagaku Ribbon Recorder	 NDK 011S	284mm x 66'	NDK 2516P50		Call us for your specific application.		
Thermal Recorder	 NDK 304S	114mm x 115'	NDK 11401T		Black Image No Pen/Ribbon Required		
Okhura Electric F15RC Series	 OKH 006S	184mm x 23.4M	OKH F15RC 105		Call us for your specific application.		
210mm Wide Recorders	 OKH 008S	210mm x 66'	OKH HZCAA0852AF001				
Omega Engineering CT 418	 AIN 008C	8-3/16"	AIN CT 418-100F-7 (AIN 503)	 MP 232P	CT 400-Blue CT 400-Red	Blue Red	MP 82-22-0103-06 MP 82-22-0102-06
CT 485RS	 OEA 008C	8-1/4"	OEA CT 485-CWF		CT 485-PB CT 485-PR		
CT 500, CT 501, CT 521	 BH 006C	4-5/16"	BH CT-501-100F-1 (BH 14-0051) BH CT-521-120F-1 (BH 14-0075)	—	Call us for your specific application.		
CT 1000, CT 1700	 KPC 010C	10-3/4"	KPC CT-1000C-100/7 (KPC 105/0410)	 KPC 095P	CT-1000-Red	Red	KPC 82-95-2012-05
CT 4500 Classic	 BN 012C	11-7/8"	BN CTC-4500C-0-100-7 (BN 14479)	 MP 012P	BN 30735489-002	Red	MP 82-39-0202-05

Instrument/Model No.(s) To Fit:	Chart			Our Matching Pen or Ribbon			
	Format	Size	Order By Number	Key	P/N	Color	Order By Number
Omega Engineering (Continued) CT 4500 Truline	 BN 312C	11-7/8"	BN CT-4500C-Thermal (BN 30755317)		Black Image No Pen/Ribbon Required		
OM-272, OM-372, OM-472	 MYK 312S	12" x 100'	OM-TR27E (MYK 414446) OM-TR27M (MYK 414460)				
OM-500	 YOK 009S	210mm x 53'	OM 500-2FF (YOK B9541AR)	 YOK 013P	YOK B9541AT	YOK 64-11-400V-01	
RD 2000, RD 2020, RD 2030, 1201, 1202	 LNR 009S	230mm x 83'	LNR 0100-0026	 MP 006P	0100-0105 0100-0106	Blue Red	MP 82-12-0273-05 MP 82-12-0272-05
R100 (µR100)	 YOK 004S	113.75mm x 53'	RD 100-ZFP (YOK B9565AW)	 YOK 010P  YOK 009P	B9565 AP B9565 AQ B9565 AR B9565 AS	Red Green Blue Violet	YOK 82-24-0302-03 YOK 82-24-0204-03 YOK 82-24-0103-03 Plotter Pen YOK 82-24-0406-03
RD 110/111	 YOK 007S	200mm x 66'	YOK B9573 AN	 YOK 012P	YOK B9573RR	YOK 64-11-200V-01	
RD 120	 YOK 013S	344mm x 65'	RD 120-ZFP (YOK B9538RN)	 YOK 013P	YOK B9541AT	YOK 64-11-400V-01	
RD 288	 RTI 002S	2-9/16" x 63'	SL-650 (RTI 2279A)		No Pen/Ribbon Required		
RD 3720	 YOK 015S	270mm x 20M	RD 3720ZFP (YOK B9619AH)	 YOK 028P	RD 3720-01 B9586YA	Red	YOK 64-28-0102-03















Instrument/Model No.(s) To Fit:	Chart			Our Matching Pen or Ribbon			
	Format	Size	Order By Number	Key	P/N	Color	Order By Number
Omega Engineering (Continued) 141, 142, 143, RD2010	 LNR 004	120mm x 100'	LNR 0100-0011	 MP 006P	0100-0105 0100-0106	Blue Red	MP 82-12-0273-05
	 LNR 005	120mm x 52'	LNR 0100-0028				MP 82-12-0272-05
145, 146	 LNR 003	120mm x 27'	LNR 0100-0032				
156	 LNR 006	162mm x 100'	LNR 0100-0017	 MP 002P	0100-0102 0100-0101	Red Blue	MP 82-09-0132-05C MP 82-09-0133-05C
180A, RD180A	 YOK 007	200mm x 66'	YOK B9573AN	 YOK 012P	B9573RR		YOK 64-11-200V-01
250, 255, 285, 456, 486, 555, 585, 595	 LNR 011	280mm x 100'	LNR 0100-0025	 MP 006P	0100-0105 0100-0106	Blue Red	MP 82-12-0273-05 MP 82-12-0272-05
600, 610, 620, 640	 BBC 010	270mm x 106'	BBC 195-5970-E00	 BBC 002P	5L-301 5L-302	Red Blue	BBC 64-01-0102-03
630	 BBC 005	139.5mm x 106'	BBC 195-6140-E00				BBC 64-01-0203-03
Palmer 12" Case	 PLM 013C	11-1/4"	PLM 12B100	 MP 012P	-		MP 82-39-0202-06 MP 82-39-0303-06



Instrument/Model No.(s) To Fit:	Chart			Our Matching Pen or Ribbon			
	Format	Size	Order By Number	Key	P/N	Color	Order By Number
Partlow LF, MF, RF	 PW 010C	9-15/16" (100/box)	PW A225F 24H	 MP 206P	60500401 60500403	Green Red	MP 82-32-0314-05 MP 82-32-0312-05
	 MP 179P	60500501	Red	MP 82-87-0012-06			
					 PW 009C	9-15/16" (50/box)	PW PSR-1-36F-24H
	 PW 007C	8" (50/box)	PW PSD217C (RevA) 31D				
MRC 7000	 PW 010C	9-15/16" (100/box)	PW 00213825 24H	 MP 206P	60500401 60500403	Green Red	MP 82-32-0314-05 MP 82-32-0312-05
	 MP 179P	60500501	Red	MP 82-87-0012-06			
 PW 110C					10"	PW 00215201	N/A
	 PW 111C	11"	PW 00215204				

Instrument/Model No. (s) To Fit:	Chart			Our Matching Pen or Ribbon			
	Format	Size	Order By Number	Key	P/N	Color	Order By Number
Partlow (Continued) Versa Chart (Continued)	 PW 112C	11-7/8"	PW 00215206	N/A			
Perkin Elmer Lambda, 983	 PR 310S	272mm x 82'	PR L106-1433		Blue Image No Pen/Ribbon Required		
LCI-100, GP-100	 PR 020S	283mm x 100'	PR N625-1026				
R-32	 PR 022S	9-1/2" x 105'	PR 5600-6671	 PR 006P	-	Black	PR 82-20-0071-03
R-24A, R-24B	 PR 010R	11" x 16-3/4" 100 sheets/pack	PR 435-7203			Red	PR 82-20-0072-03
R-100	 PR 019S	274mm x 85'	PR CP-33384-0	 MP 006P	-	Black	MP 82-12-0271-05
						Red	MP 82-12-0272-05
						Blue	MP 82-12-0273-05
						Green	MP 82-12-0274-05
Sigma 10, 15	 PR 008S	8-1/2" x 184'	PR 332-1910		Blue Image No Pen/Ribbon Required		
	 PR 015S		PR 332-1911				
Terminal Roll	 PR 308S	8-1/2" x 250'	PR T50-331 PR N500-0037				
021, 137B, 180, 221 Slave, 421, 521, 621	 PR 002R	10-29/32" x 34" 100 charts on core	PR 021-6310	 PR 006P	-	Black	PR 82-20-0071-03
		11" x 34" 100 charts on core	PR 221-1604			Red	PR 80-20-0072-03
		11" x 30" 100 charts	PR 180-2005			Green	PR 80-20-0074-03











Instrument/Model No.(s) To Fit:	Chart			Our Matching Pen or Ribbon			
	Format	Size	Order By Number	Key	P/N	Color	Order By Number
Perkin Elmer (Continued) 23	 LNR 011S	280mm x 100'	LNR 0100-0025	 LNR 002P	-	Single Channel Pen Red LNR 82-09-0132-05C	
				 MP 006P		Two-Channel Pen Green MP 82-12-0044-05 Red MP 82-12-0272-05	
56, 200, 320, 330, 561	 PR 013S	276mm x 100'	PR 056-7300 PR 159-1003 PR 165-1003	 MP 006P	-	Black MP 82-12-0271-05 Red MP 82-12-0272-05 Blue MP 82-12-0273-05 Green MP 82-12-0274-05	
57, 560, 576	 PR 014S	280mm x 100'	PR 570-0953				
137B, 237, 337	 PR 014R	8-1/2" x 11" 100 charts	PR 237-1028 PR 337-1203	 PR 006P	-	Black PR 82-20-0071-03 Red PR 82-20-0072-03 Green PR 80-20-0074-03 3 pens per pack	
167, 257, 267, 297, 298, 299, 299B, 397, 398, 399, 399B, 457, 467, 567, 597, 598, 599, 599B, 681, 682, 683, 684, 781, 782, 783, 1310, 1320, 1330, 1420, 1430	 PR 002S	215mm x 80'	PR 457-5001 PR 5100-4367				
	 PR 023S	216mm x 75'	PR 199-1043				
180, 281, 281B, 283, 283B, 580, 580B	 PR 016S	272mm x 75'	PR 280-1001 (5101-3600)				
197, 297, 397, 597	 PR 012S	215mm x 80'	PR 280-1050 (5102-1001)				
200, 561	 PR 017S	274mm x 99'	PR 18250-V	 MP 006P	-	Black MP 82-12-0271-05 Red MP 82-12-0272-05 Blue MP 82-12-0273-05 Green MP 82-12-0274-05 5 pens per pack	
257, 267	 PR 002S	215mm x 80'	PR 472-5089	 PR 006P	-	Black PR 82-20-0071-03 Red PR 82-20-0072-03 Green PR 80-20-0074-03 3 pens per pack	





New products are added every day. If the charts or disposable pens that you need are not listed, please call us.

Instrument/Model No.(s) To Fit:	Chart			Our Matching Pen or Ribbon			
	Format	Size	Order By Number	Key	P/N	Color	Order By Number
Perkin Elmer (Continued) 554, 555, 559, 559A	 PR 018S	270mm x 75'	PR 093925 (CP 30461-0)	 PR 006P	-	Black Red Green	PR 82-20-0071-03 PR 82-20-0072-03 PR 80-20-0074-03 3 pens per pack
	 PR 308S	8-7/16" x 280'	PR N500-0037		Black Image No Pen/Ribbon Required		
	 PR 060R	8-1/2" x 11" 100 charts	PR 007-1201	 PR 006P	-	Black Red Green	PR 82-20-0071-03 PR 82-20-0072-03 PR 80-20-0074-03 3 pens per pack
 PR 061R	PR 007-1493						
 PR 025R	PR 007-1271						
Phillips Electronic Instruments SP3-100, SP3-200, SP3-300, PU9510	 PSE 007S	200mm x 75'	PSE 641749	 PSE 030P	PM 9856/05 PM 9857/05 PM 9857B/05 PM 9805/03 62-71881305	Blue Red Blue Red Blue	PSE 64-30-0103-01C PSE 64-30-0202-01C PSE 64-30-0203-01C PSE 64-30-0102-01C PSE 64-30-0103-01C
Photo Recording/ Direct Print Papers Honeywell Visicorders, Bell & Howell, Yokogawa High Performance Recorders	 PHS 009S	8" x 200', Extra thin Sensitive Side Out Pink Yellow	PHS GXT 8x200 Sp2 PHS HXT 8x200 Sp2		No Pen/Ribbon Required		
		8" x 100' Standard Thickness Sensitive Side Out Yellow	PHS HSTD 8x100 Sp2				
	 PHS 008S	8" x 100' Standard Thickness Sensitive Side Out Pink	PHS GSTD 8x100 Sp2				
	 PHS 007S	7" X 200' 111 Thickness Sensitive Side In Pink	PHS GXT 7x200 Sp111				







Instrument/Model No.(s) To Fit:	Chart			Our Matching Pen or Ribbon			
	Format	Size	Order By Number	Key	P/N	Color	Order By Number
Photo Recording/ Direct Print Papers (Continued) Honeywell Visicorders, Bell & Howell, Yokogawa High Performance Recorders (Continued)	 PHS 012S	12" x 200' Standard Thickness Sensitive Side In Pink	PHS GSTD 12x200 Sp1				No Pen/Ribbon Required

Printrex — See dataGRAPHIC® section, pg. 103, see Well Loggers and Recorders, pg. 82

Rank Taylor Hobson Talyrond, Talyrond-Bryant, Talyrond-Micromatic	 TH 004C	4-1/2"	TH 112/355				No Pen/Ribbon Required
	 TH 005C	5-7/8"	TH A112/1314E English TH A112/1314M Metric				
Talysurf	 TH 002S	2-1/2" x 200'	TH Talysurf 112/329				
Raytheon DE-719 Series	 RN 008S	7-1/64" x 60'	RN 7430-1001-G1				Black Image No Pen/Ribbon Required
DE-725C	 RN 013S	3-1/2" x 50'	RN 585164-1				
J-12	 RN 030S	4-31/32" x 50'	RN J-12 (6ZPBS00009)				
LSR-1811 Line Scan Recorder	 RN 028S	18-1/4" x 200'	RN 553583-6				
LSR-910M & SAR Series	 RN 029S	9-1/4" x 65'	RN 553583-8				
TDU 850	 RN 308S	8-3/4" x 165'	RN G-329290-2				

Instrument/Model No.(s) To Fit:	Chart			Our Matching Pen or Ribbon			
	Format	Size	Order By Number	Key	P/N	Color	Order By Number
Raytheon (Continued) TDU 1200	 RN 003S	12.1" x 158'	RN G-529280-2			Black Image No Pen/Ribbon Required	
Thermal Array Recorder	 RN 308S	8-1/2" x 280'	RN G-494579				
Thermal Display Printer	 RN 097S	79mm x 66'	RN G-263210-1				













Rikadenki - See Soltec/Rikadenki, pg. 72

Robertshaw Strip Recorder	 RS 004S	4-3/8" x 65'	RS 501-01	N/A			
A-100, A-200, B-100	 RS 012	11-1/4"	RS 41800-A9 RS 26943-A1	 MP 012P	-		MP 82-39-0101-06 MP 82-39-0202-06
Rockwell CRG, Temcorectors, 205	 PH 010C	9-15/16"	PH 205-00-128-04 PH 209-40-128-17	 MP 012P	-		MP 82-39-0101-06 MP 82-39-0202-06
EMCO	 PH 012C	11-1/4"	PH EM-20800 PH PE-20500				

Cream-colored Circular Charts





As our products evolved and we became a world leader in chart production, we wanted to differentiate our offer from that of the competition. The cream color was chosen to portray a quality precision chart. We have had positive comments from many of our customer on the rich feel and appearance of our circles.

Our customers tell us they prefer the cream color, as it does not glare in direct sunlight and scanners in field evaluations are calibrated to work best with non-white paper.

Instrument/Model No.(s) To Fit:	Chart			Our Matching Pen or Ribbon			
	Format	Size	Order By Number	Key	P/N	Color	Order By Number
Rosemount 4100	 CLH 002S	120mm x 105'					
	 CLH 001S	120mm x 52'					
4200	 CLH 002S	120mm x 105'					
	 CLH 001S	120mm x 52'					
4500	 CLH 009C	10"					
Rustrak Series 2W	 RTI 005S	5-3/16" x 68' 2 Channel	RTI A-A (50 Div-50 Div)			Black Image No Pen/Ribbon Required	
Series 3W	 RTI 007S	7-25/32" x 62' 3 Channel	RTI C-6068 Style W-AAA 50 Div/Channel				
Series 6000	 ANG 005S	5-3/8" x 68'	C7215 Style ANG AL100MM				
Series 7000	 RTI 005S	5-3/16" x 68'	RTI C6978 Style A-100MM				
200, 400	 RTI 002S	2-5/16" x 63' 1 Channel	RTI 2279 Style A (50 Div) RTI 2597 Style G (20 Div) RTI 2428 Style H (40 Div) RTI 2256 Style I (30 Div) RTI 2780 Style K (60 Div)				
RT-8000	 BN 312C		BN 30755317	N/A			

Instrument/Model No. (s) To Fit:	Chart			Our Matching Pen or Ribbon			
	Format	Size	Order By Number	Key	P/N	Color	Order By Number

Schlumberger — See Well Loggers and Recorders, pg. 82

Seiko DPU 40	 SKO 303S	79mm x 20M	SKO TP40-20-CL		Black Image No Pen/Ribbon Required
MTP 102	 SKO 331S	38mm x 9M	SKO TP102-9		
MTP 201/STP 211	 SKO 333S	58mm x 25M	SKO TP201-211-25		
STP 411	 SKO 304S	122m x 25M	SKO TP411-25		













Measurement, Equilibrium, Quality Control and Accuracy Verification











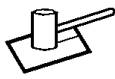



To compensate for the inherent instability of paper, we designed our chart papers to be in equilibrium at the conditions which we manufacture. Incidentally, these conditions of testing meet the requirements of the Technical Association of the Pulp and Paper Industry (TAPPI).













We specify a moisture content which equates to dimensional stability at the TAPPI conditions. The approved test method is TAPPI T402.













Prior to measuring, samples should be conditioned to TAPPI T402 for a period of at least 2 hours.











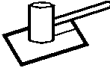

Sometimes, a recording chart will appear to be out-of-spec and unfit for use upon initial examination; it may be wise to allow your chart to condition to the environment before you calibrate, especially if the cost of accuracy or the importance of the test is a priority.

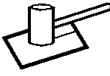



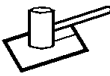



Instrument/Model No.(s) To Fit:	Chart			Our Matching Pen or Ribbon			
	Format	Size	Order By Number	Key	P/N	Color	Order By Number
Sekonic S-201 GP	 EST 309S	9-1/4" x 164'	EST 822B914			Black Image No Pen/Ribbon Required	
—	 SKN 004S	113.5mm x 39'	SKN T09418 SKN 881A-010	Call us for your specific application.			
	 SKN 011S	275mm x 66'	SKN 885-03				
	 EST 112S	275mm x 69'	EST 882B904 (cross reference to SKN 885-04)				
Shimadzu Scientific Instruments C-R1A, C-R1B	 SZU 308S	8-3/16" x 170'	SZU 221-13391-01			Black Image No Pen/Ribbon Required	
C-R3A	 SZU 307S	8-3/16" X 167'	SZU 221-25412				
C-R4A	 SZU 311S	255mm x 148'	SZU 223-02000-12				
C-R5A, CR501	 SZU 312S	208mm x 148'	SZU 223-02037-01				
	 SZU 310S	208mm x 167'	SZU 223-02037-02				
C-R6, CR601	 SZU 307S	8-3/16" x 167'	SZU 221-25412				

Instrument/Model No.(s) To Fit:	Chart			Our Matching Pen or Ribbon			
	Format	Size	Order By Number	Key	P/N	Color	Order By Number
Simpson Electric	 SEC 002S	64mm x 50'	SEC ZB247/20/120 (22311) SEC 02614 (ZB-299) SEC 22155		No Pen/Ribbon Required		
Soltec/Rikadenki DS-250	 RKI 023S	270mm x 99'	RKI RD1-01-25-30M		Please call for quotation.		
DS 6000/8000	 RKI 021S	270mm x 66'	RKI ZD1-01-25-20M				
	 RKI 023S	270mm x 99'	RKI RD1-01-25-30M				
R-OX Series, R-50, R-60, R-300	 RKI 011S	282mm x 50'	RKI RR1-01-25-15M				
	 RKI 023S		RKI ZR1-01-25-15M RKI H-25-1Z-15M				
SA-100P, SH 100 PD, 8000 Series	 RKI 003S	113.5mm x 40'	RKI ZA1-01-10-12M				
TA 200-839, 938, 1238	 RKI 008S	215mm x 165'	RKI RN4-00-20-50M		Black Image No Pen/Ribbon Required		
1200 Series	 RKI 022S	284mm x 66'	RKI RN2-01-25-20M RKI RN3-01-25-20M	 MP 006P	PF-1201 PF-1206	Red Green	MP 82-12-0392-05 MP 82-12-0044-05
3300	 RKI 023S	289mm x 99'	RKI RKI-01-26-30M	 MP 055P	PF-0501 PF-0502 PF-0503 PF-0504 PF-0505 PF-0506	Red Black Blue Brown Purple Green	MP 64-04-0102-03 MP 64-04-0101-03 MP 64-04-0103-03 MP 64-04-0108-03 MP 64-04-0106-03 MP 64-04-0104-03
	 RKI 016S	289mm x 66'	RKI ZK1-01-26-20M RKI ZK1-06-26-20M				







Instrument/Model No.(s) To Fit:	Chart			Our Matching Pen or Ribbon			
	Format	Size	Order By Number	Key	P/N	Color	Order By Number
Soltrec/Rikadenki (Continued) 4201, 4202, 6723	 RKI 005S	142mm x 33'	RKI ZM1-01-12-10M	 MP 006P	PF-0701 PF-0702	Short Red Long Black	MP 82-12-0392-05 MP 82-12-0341-05
	 RKI 004S	142mm x 50'	RKI ZM1-01-12-15M				
8K23	 RKI 316S	378mm x 656'	RKI ZS3-02-38-200M RKI 0511-1170		Black Image No Pen/Ribbon Required		
8K29	 RKI 097S	110mm x 263'	RKI RS5-02-11-80M		2-40mm channels Black Image No Pen/Ribbon Required		
8K31, 32, 33	 RKI 006S	120mm x 132'	RKI ZS8-01-12-40M		Black Image No Pen/Ribbon Required		
	 RKI 308S	200mm x 132'	RKI ZS8-01-20-40M				
8K42, 43	 RKI 315S	379mm x 492'	RKI ZS10-01-38-150M RKI 0511-3042				
Sparling 10"	 SP 010	10"	SP 140822	 MP 012P	-	MP 82-39-0101-06 MP 82-39-0202-06	
Spectra-Physics — See dataGRAPHIC® section, pg. 104							
Taylor Hobson — See Rank Taylor Hobson, pg. 67							
Taylor Instruments — See ABB Instrumentation, pg. 8							
Tektronix Thermal Printer	 TEK 302S	2" x 85'	TEK 006-2408-00		Black Image No Pen/Ribbon Required		











Instrument/Model No.(s) To Fit:	Chart			Our Matching Pen or Ribbon			
	Format	Size	Order By Number	Key	P/N	Color	Order By Number
Texas Instruments Older Models include: Servoriter 2 FLO 4W5D, FLO 2W5D	 TX 011S	11-3/16" x 100'	TX A 7A7 B, H, S, T, U, & W Series	 MP 006P	Universal Series 12 Pens	.156" nib Black MP 82-12-0211-05 Red MP 82-12-0212-05 .417" nib Black MP 82-12-0441-05 Red MP 82-12-0442-05 Blue MP 82-12-0443-05 Green MP 82-12-0444-05	
PC 100	 TX 303S	2 15/32" x 250'	TX TP 30250			Blue Image No Pen/Ribbon Required	
Tigraph 100/200	 TX 305S	114mm x 82'	TX 2207291-001		Black Image No Pen/Ribbon Required		
5015, 5040, 5220, 5225	 TX 302S	2-1/4" x 165'	TX TP 27225		Blue Image No Pen/Ribbon Required		
5050, 5135	 TX 301S	2-1/4" x 85'	TX TP 20225				
703/1200, 707/1200, 733/1200	 TX 308S	8-1/2" x 90'	TX 2248162-001		Black Image No Pen/Ribbon Required		
730, 732, 733, 735, 742, 755, 770	 TX 113S	8-15/32" x 300'	TX 213714				
732, 742, 755, 763, 765, 767, 769, 770, 780, 781, 783, 785, 787	 TX 108S	8-15/32" x 100'	TX 972603				
H.O. Trerice All Models	 HOT 010S	9-15/16"	HOT 9022A		 MP 012P	Replaces Bulk Ink	Black MP 82-39-0101-06 Red MP 82-39-0102-06 Blue MP 82-39-0203-06















Instrument/Model No.(s) To Fit:	Chart			Our Matching Pen or Ribbon			
	Format	Size	Order By Number	Key	P/N	Color	Order By Number
United Electric Controls T-150	 UD 009C	8"	UD 6282-72		No Pen/Ribbon Required		
	 UD 004C	8"	UD 6282-226	 MP 012P	—	.14" nib Black MP 82-39-0101-06 Red MP 82-39-0102-06 Blue MP 82-39-0103-06 Green MP 82-39-0104-06 Purple MP 82-39-0106-06 .37" nib Black MP 82-39-0201-06 Red MP 82-39-0202-06 Blue MP 82-39-0203-06 Green MP 82-39-0204-06 Purple MP 82-39-0206-06 .60" nib Black MP 82-39-0301-06 Red MP 82-39-0302-06 Blue MP 82-39-0303-06 Green MP 82-39-0304-06 Purple MP 82-39-0306-06 .83" nib Black MP 82-39-0401-06 Red MP 82-39-0402-06 Blue MP 82-39-0403-06 Green MP 82-39-0404-06 Purple MP 82-39-0406-06	
1300	 UD 015C	10"	UD 6282-220		No Pen/Ribbon Required		
	 UD 010C		UD 6282-218	 MP 012P	—	See Model No. T-150 See Accessories section, pg. 94, for Pen Arm 80-36-2290-01.	
650 Series	 UD 007C	6"	UD 6282-231 PS		No Pen/Ribbon Required		
	 UD 006C		UD 6282-231	 MP 006P	D-6219-652 (Old Style)	Red	MP 82-12-0412-05
6B01, 6D01, A01, C01	 UD 006C	6"	UD 6282-231	 MP 012P	—	See Model No. T-150 See Accessories section, pg. 94, for Pen Arm 80-36-2290-01.	



Instrument/Model No.(s) To Fit:	Chart			Our Matching Pen or Ribbon			
	Format	Size	Order By Number	Key	P/N	Color	Order By Number
Uster	 UR 003S	99mm x 50'	UR 120451-4	 INK 002P	-	16 oz. Red Black	INK 71-50-1742-01
	 UR 007S		UR 120451-11				INK 71-50-1741-01
	 UR 005S	99mm x 250 sheets 3 fan-fold packs per box	UR 120451-00041				
	 UR 005S	99mm x 1000 sheets 3 fan-fold packs per box	UR 120451-00200				
	 UR 001S	90mm x 1000 sheets 1 fan-fold pack per box	UR 120451-00300				
	 UR 006S	59mm x 93'	UR 199482-60				

Varian, Varian Associates — See Varian/Carq









Varian/Carq A5, A6, A10, G10, G11, G14, G1000, G14A, G22A	 VN 006S	6-3/8" x 85'	VN 5A	 LNR 002P	VN 71-000211-00 VN 71-000222-00 VN 71-000233-00 VN 71-000244-00	Black Red Blue Green	LNR 82-09-0131-05C LNR 82-09-0132-05C LNR 82-09-0133-05C LNR 82-09-0134-05C
A-20, A-25, A-30, G-15, G-2000, G-2500, G-4000, 9176	 VN 012S	11-9/32" x 120'	VN 158A (00-971490-01)	 VN 010P	VN 03-905120-05 VN 03-905120-06	Blue Black	VN 82-33-0033-06A VN 82-33-0011-06A
			VN 415A (71-000197-00)				
A-60, A-60A, A-60D	 VN 004R	11" x 26" 500 sheets/pack	VN S-60A, VN S-60C, VN S-60C Black	Call us with your specific application.			
Cary 12, 17D, 118, 210, 219, SuperScan 1, 2, 3, 1BE, 1E	 VN 012S	305mm x 100'	VN 952019-01	 VN 006P	VN 10-260000-99 VN 10-260001-00 VN 10-260001-01 -	Black Red Green Blue	VN 82-46-0011-05A VN 82-46-0012-05A VN 82-46-0014-05A VN 82-46-0013-05A











Instrument/Model No.(s) To Fit:	Chart			Our Matching Pen or Ribbon			
	Format	Size	Order By Number	Key	P/N	Color	Order By Number
Varian/Cary (Continued) Cary 14, 17, 170 Series	 AP 012S	12" x 120"	AP 1400 (VN 10-260000-54)	 MP 006P	VN 10-260000-01 VN 10-260001-02 VN 10-260001-03 VN 10-260001-04	Black Red Blue Green	MP 82-13-0011-05 MP 82-13-0012-05 MP 82-13-0013-05 MP 82-13-0014-05 5 pens per pack
CFT-20, FT-80, FT-80A	 VN 039R	11" x 16-13/16" 500 sheets/pack	VN CFT-20 (V-20)	Call us for your specific application.			
	 VN 031R		VN 360K10 Black				
E Line Series	 VN 013R	11"-11/16" x 16-25/32" 100 sheets/pack	VN EPR Chart A				
	 VN 007R		VN Plain Sheet (V-EPR-BL)				
EM-360, SuperScan 2, 3	 VN 022R	11" x 16-1/2"	VN 360K101 (00-98268-01)				
		278mm x 448mm 100 sheets/pack	VN 71-100033-00 (S53)				
EM-390	 VN 014R	11" x 16-13/16" 100 sheets/pack	VN FT-804 (00-938268-01) VN 390 (950209-02)				
HA-100, HA-100A, HA-100D, HR-220, VL-200, XL-300, XL-400, XL-100(CW), XL-100(CW & FT)	 VN 004R	11" x 26" 100 sheets/pack	VN S-100A, VN S-100XL, VN S-220, VN XL200, VN XL-100, VN S-XLFT-100				
T-60	 VN 010R	8-1/2" x 11" 100 sheets/pack	VN S60-T				
	 VN 015R	8-1/2" x 11" 100 blank sheets	VN V-60-T-BL				

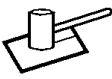



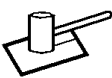



Instrument/Model No.(s) To Fit:	Chart			Our Matching Pen or Ribbon			
	Format	Size	Order By Number	Key	P/N	Color	Order By Number
Varian/Cary (Continued) Vista 401	 VN 308S	8-1/2" x 184'	VN 03-906362-0		Black Image No Pen/Ribbon Required		
	 VN 309S		VN 03-906265-0		Blue Image No Pen/Ribbon Required		
1200 Series	 LNR 026S	230mm x 83'	LNR 0100-0026 (VN 00-997289-01)	 MP 006P	VN 71-000216-00	Red	MP 82-12-0042-05
3400	 PNR 202S	4.33" x 150'	PNR NO 202 (VN 03-917650-00)		Black Image No Pen/Ribbon Required		
4270, 4290	 VN 310S	9-25/64" x 183'	VN 00-997-096-01				
Wallace & Tiernan Various	 WL 010C	10-5/16"	WL PXA 58351	 MP 012P	U-2552	Red	MP 82-39-0262-05
	 WL 012C	11-1/8"	WL MC 40109				
	 WL 110C	10-5/16" 2 color	WL PXB 59867				
	 WL 004S	4-3/8" x 66'	WL PXB 46150	Call us for your specific application.			
	 WL 005S	120mm x 50'	WL UXF 28477				













Instrument/Model No.(s) To Fit:	Chart			Our Matching Pen or Ribbon			
	Format	Size	Order By Number	Key	P/N	Color	Order By Number
Warren Automatic Controls (Tagliabue) Various	 TE 010C	8-7/8"	TE 206062	 MP 012P	-	Black	MP 82-39-0101-06
	 TE 012C	12"	TE 205876			Red	MP 82-39-0202-06











Watanabe — See Graphtec, pg. 37













Weather Measure & Weathertronics Campbell-Stokes Sunshine Recorder	 GVT 008R	1.24" x 12.44" 150 charts/pack	GVT 0063-9625 WRT C0850-11	"Solar Powered"			
EPR-100A, EPR-200A Polyrecorders	 WME 008S	170mm x 15M	WME C-EPR-102	Call us for ink & pens.			
H311 Hygrothermograph	 WME 008S	7-1/8" x 13-1/4" 100 sheets/pack	WME C311-W-HF (M699124)	 MP 179P	-	Red	MP 82-87-0011-06
HiQ Hygrothermograph	 WRT 001R	7-1/16" x 12-9/16" 100 sheets/pack	WRT 50202			Blue	MP 82-87-0012-06
	 WRT 008R	7-1/8" x 12-3/4" 25 sheets/pack	WRT 50208			Purple	MP 82-87-0016-06
P401 Mechanical Pyronovagraph (Solar Radiation Recorder)	 WME 003S	70mm x 49'	WME C401-W	<i>See our Universal Marking Systems section, pg. 132, for ink.</i>			
P501-I Remote Recording Rain Gage, P511-E Remote Recording Heated Snow Gage	 WME 009S	6-11/16" x 100'	WME C522A-50				





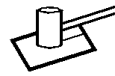











Instrument/Model No. (s) To Fit:	Chart			Our Matching Pen or Ribbon			
	Format	Size	Order By Number	Key	P/N	Color	Order By Number
Weather Measure & Weathertronics (Continued) W101-OC Remote Recording Skyvane I	 WME 010S	275mm x 68'	WME C101-0	 MP 179P	-	Red	MP 82-87-0012-06
						Blue	MP 82-87-0012-06
W123 Recording Wind System	 WME 002S	2-9/16" x 63'	WME C-123D		Black Image No Pen/Ribbon Required		
2035 Series Wind Systems Using 8700 Series Recorders	 WRT 004S	4-15/32" x 40'	WRT 87401	 MP 179P	-	Red	MP 82-87-0012-06
						Blue	MP 82-87-0012-06
						Purple	MP 82-87-0016-06
						<i>See our Universal Marking Systems section, pg. 132, for ink.</i>	
2360 & 2365 Dual Channel Recording Wind System	 WRT 005S	5-3/16" x 68'	WRT 23601		Black Image No Pen/Ribbon Required		
Weksler							
6"	 WR 008C	6"	WR W120-30-6	 MP 012P	-	.14" nib	
8"		8"	WR W120-30-8			Black	MP 82-39-0101-06
						Red	MP 82-39-0102-06
						Blue	MP 82-39-0103-06
10"	 WR 010C	10"	WR W120-30-10			Green	MP 82-39-0104-06
							Purple
						.37" nib	
						Black	MP 82-39-0201-06
						Red	MP 82-39-0202-06
						Blue	MP 82-39-0203-06
						Green	MP 82-39-0204-06
						Purple	MP 82-39-0206-06
						.60"	
						Black	MP 82-39-0301-06
						Red	MP 82-39-0302-06
						Blue	MP 82-39-0303-06
						Green	MP 82-39-0304-06
						Purple	MP 82-39-0306-06
						.83"	
						Black	MP 82-39-0401-06
						Red	MP 82-39-0402-06
						Blue	MP 82-39-0403-06
						Green	MP 82-39-0404-06
						Purple	MP 82-39-0406-06
						<i>See Accessories section, pg. 94 for appropriate pen arms.</i>	

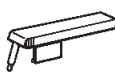



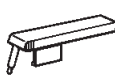



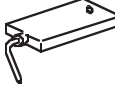

Instrument/Model No.(s) To Fit:	Chart			Our Matching Pen or Ribbon			
	Format	Size	Order By Number	Key	P/N	Color	Order By Number
Well Loggers & Recorders GC Wireline™ Recording Charts	 PNP 004S	8-63/64" x 365' (700 pages)	PNP Log Chart No. 001		Black Image No Pen/Ribbon Required 6-1/4" Cross-Perf & Fold 1-13/16" Cueing/Sensor Block		
		8-3/4" x 417' (800 pages)	PNP Log Chart No. 004		Black Image No Pen/Ribbon Required 6-1/4" Cross-Perf & Fold 1-13/16" Cueing/Sensor Block		
		8-63/64" x 365' (700 pages)	PNP Log Chart No. 006		Black Image No Pen/Ribbon Required 6-1/4" Cross-Perf & Fold 1-3/4" Cueing/Sensor Block		
	 PNP 005S	8-3/4" x 417' (800 pages)	PNP Log Chart No. 005		Black Image No Pen/Ribbon Required 6-1/4" Cross-Perf & Fold 2-5/16" Cueing/Sensor Block		
			PNP Log Chart No. 008		Black Image No Pen/Ribbon Required 6-1/4" Cross-Perf & Fold 1/2" Cueing/Sensor Block		
	 PNP 009S	8-45/64" x 417' (800 pages)	PNP Log Chart No. 009		Black Image No Pen/Ribbon Required 6-1/4" Cross-Perf & Fold 1/2" Cueing/Sensor Block		
	 PNP 013S	12" x 496' (700 pages)	PNP Chart Log No. 012		Black Image No Pen/Ribbon Required 8-1/2" Cross-Perf & Fold (No Cueing/Sensor Block)		
	 PNR 013S	12" x 500'	PNR Log 12x500		Black Image No Pen/Ribbon Required		
	 PNP 014S	8-63/64" x 521' (1,000 pages)	PNP Log Film		White Opaque Film - Black Image No Pen/Ribbon Required 6-1/4" Cross-Perf 1-13/16" Cueing/Sensor Block		
	 PNR 014S	12" x 500' (706 pages)	PNR Log 12x500 XPERF8.5"		Black Image No Pen/Ribbon Required 8-1/2" Cross-Perf (No Cueing/Sensor Block)		
Gulton AP-20, 20T	 GI 302S	2-1/4" x 150'	GI D20M	Black Image No Pen/Ribbon Required			

Instrument/Model No.(s) To Fit:	Chart			Key	Our Matching Pen or Ribbon		
	Format	Size	Order By Number		P/N	Color	Order By Number
Well Loggers & Recorders (Continued) Gulton Micro D44, Micro P44, 44-L, 44-T	 GI 305S	4-31/32" x 150'	GI D44M		Black Image No Pen/Ribbon Required		
	 GI 319S	8-3/4" x 150'	GI D80M		Black Image No Pen/Ribbon Required		
Gulton MT-80T, 80T	 GI 302S	8-3/4" x 100'	GI D80M 100FT	Black Image No Pen/Ribbon Required			
	 PPR 316S	12" x 300'	PPR GUL308-0002	Black Image No Pen/Ribbon Required			
	 GI 318S	8-3/4" x 300' (576 pages)	GI 205545	Black Image No Pen/Ribbon Required 6-1/4" Cross-Perf & Fold (No Cueing/Sensor Block)			
Gulton Seismic Recorders	 SGR 908S	8-63/64" x 500' (960 pages)	SGR DH401500	Black Image No Pen/Ribbon Required 6-1/4" Cross-Perf & Fold 2-1/4" Cueing/Sensor Block			
	 PNR 319S	8-45/64" x 130'	PNR PRINTEX 2316-0001	Black Image No Pen/Ribbon Required			
	 PNR 007S		PNR PRINTEX 820ROLL	Black Image No Pen/Ribbon Required			
Printex 820/822	 PNP 009S	8-45/64" x 417' (800 pages)	PNP Log Chart No. 009	Black Image No Pen/Ribbon Required 6-1/4" Cross-Perf & Fold 1/2" Cueing/Sensor Block			
	 SGR 908S	8-63/64" x 500' (960 pages)	SGR DH401500	Black Image No Pen/Ribbon Required 6-1/4" Cross-Perf & Fold 2-1/4" Cueing/Sensor Block			
Schlumberger Well Loggers & Seismic Recorders	 SGR 908S	8-63/64" x 500' (960 pages)	SGR DH401500	Black Image No Pen/Ribbon Required 6-1/4" Cross-Perf & Fold 2-1/4" Cueing/Sensor Block			

Instrument/Model No.(s) To Fit:	Chart			Our Matching Pen or Ribbon				
	Format	Size	Order By Number	Key	P/N	Color	Order By Number	
Weschler Instruments R44B	 CLH 001S	120mm x 52'	See Eurotherm Chessell 300, 301, pg. 25.					
	 CLH 003S	120mm x 26'						
Type A	 WE 008C	6-7/8"	WE542D768H02				See Universal Series 39 pens, pg. 128.	
Type 45	 WE 008C	6-7/8"	WE542D768H02					
Western Graphtec — See Graphtec, pg. 37								
Westinghouse/C.C.D./ Rosemount F44, G44, K44, M44, P44	 WE 007S	4-15/32" x 108'	WE 1957012	 WE 004P	542-D-716G01	Red	WE 82-75-1002-02	
G40 Optimac	 WE 004S	4-15/32" x 60'	WE 1093002	 WE 035P Steel Stylus Pen	173680	Without Scales		
						173681	Red	WE 80-22-0152-01A
							173682	Green
				175290	With Scales			
175291	Red	WE 80-22-1192-01A						
	175292	Green	WE 80-22-1204-01A					
 WE 056P	Disposable Pen							
	-	Blue	WE 82-55-0303-03					
		Green	WE 82-55-0204-03					
Type 45 (Weschler)	 WE 008C	6-7/8"	WE 542D768H02	 MP 012P	-		MP 82-39-0052-05A	















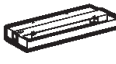

Instrument/Model No. (s) To Fit:	Chart			Our Matching Pen or Ribbon			
	Format	Size	Order By Number	Key	P/N	Color	Order By Number
Westinghouse/C.C.D./ Rosemount [Continued] Type A	 WE 009C	6-7/8"	WE 1723002	<i>See Universal Series 39 pens, pg. 128.</i>			
Type R	 WE 020S	5-23/32" x 20' to 27'	WE 237204	Call us for your specific application.			
	 WE 021S	5-23/32" x 35' to 38'	WE 838472				
75 Veritak New	 WE 003S	4-41/64" x 50'	WE 1500D91001	 WE 041P	2108C95H01 2108C94H01 2108C96H01	Bottom #2 Green WE 82-97-0104-04 Middle #1 Red WE 82-97-0202-04 Top #3 Blue WE 82-97-0303-04	
75 Veritak Old	 WE 003S	4-41/64" x 50'	WE 1500D91001	 WE 041P	2108C77H01 2108C78H01	#2 Green WE 82-98-0104-04 #1 Red WE 82-98-0202-04	
Westronics - See also Angus Electronics DDR-10 Multibank	 WES 015S	13-1/2" x 120'	WES CTM 60689-00		No Pens/Ribbons Required		
D4E, S4E, T4E	 WES 003S	4-1/2" x 48'	WES CTG 40000-00	 MP 006P	RM 668-05-04 RM 668-05-01 RM 668-05-02 RM 668-05-03 RM 668-07-01 RM 668-07-02 RM 668-07-03 RM 668-07-04 RM 668-04-04 RM 668-04-01 RM 668-04-02 RM 668-04-03 RM 668-06-01 RM 668-06-04	Black Red Blue Green Blue Red Black Green Black Red Blue Green Red Blue	MP 82-12-0211-05 MP 82-12-0212-05 MP 82-12-0213-05 MP 82-12-0214-05 MP 82-12-0403-05 MP 82-12-0402-05 MP 82-12-0401-05 MP 82-12-0404-05 MP 82-12-0261-05 MP 82-12-0262-05 MP 82-12-0263-05 MP 82-12-0264-05 MP 82-12-0232-05 MP 82-12-0233-05
		 WES 004S	4-1/2" x 82'		WES CTA 40000-00 Vertical		
D5, M5, S5	 WES 005S	5-11/16" x 100'	WES CT 051176-00 Horizontal				

Instrument/Model No.(s) To Fit:	Chart			Our Matching Pen or Ribbon			
	Format	Size	Order By Number	Key	P/N	Color	Order By Number
Westronics (Continued) D11, DD11, M11, S11	 WES 011S	11-5/6" x 100'	WES CT 108001-00	 MP 006P	RM 668-05-04	Black	MP 82-12-0211-05
					RM 668-05-01	Red	MP 82-12-0212-05
					RM 668-05-02	Blue	MP 82-12-0213-05
					RM 668-05-03	Green	MP 82-12-0214-05
					RM 668-07-01	Blue	MP 82-12-0403-05
					RM 668-07-02	Red	MP 82-12-0402-05
					RM 668-07-03	Black	MP 82-12-0401-05
					RM 668-07-04	Green	MP 82-12-0404-05
					RM 668-04-04	Black	MP 82-12-0261-05
					RM 668-04-01	Red	MP 82-12-0262-05
					RM 668-04-02	Blue	MP 82-12-0263-05
					RM 668-04-03	Green	MP 82-12-0264-05
					RM 668-06-01	Red	MP 82-12-0232-05
					RM 668-06-04	Blue	MP 82-12-0233-05
D11, M11, S11 Thermal	 WES 312S	12-3/8" x 65'	WES CTK 60224-00		No Pens/Ribbons Required		
Thermal Circular Recorder	 BN 312C	11-7/8" Diameter	WES CTQ 64504-00				
1100	 WES 004S	4-1/2" x 82' Vertical	WES CTE40000-00	 WES 091P	RM 100140-01 RM 100141-01 RM 100142-01	Red Blue Green	WES 82-91-0012-03 WES 82-91-1013-03 WES 82-91-2014-03
1200	 WES 344S	4-1/2" x 65'	WES CTL64688-00	 WES 004P	RM 100504 RM 100506 RM 100505	Red Blue Green	MP 82-A2-0102-03 MP 82-A2-0303-03 MP 82-A2-0204-03
1500, 1500A, 1560 (AR-201)	 WES 305S	119mm x 53'	WES CTL 63074-00 Black Image Thermal Film with Inkwriting Capability	 WES 071P	RM 100220-01 RM 100221-01 RM 100222-01	Red Green Blue	MP 82-71-0102-05 MP 82-71-0204-05 MP 82-71-0303-05
1600	 WES 305S	119mm x 53'	WES CTL 63074-00 Black Image Thermal Film with Inkwriting Capability	 WES 003P	RM 100470-01 RM 100472-01 RM 100471-01 RM 100473-01	Red Blue Green Purple	MP 82-A1-0102-03 MP 82-A1-0303-03 MP 82-A1-0204-03 MP 82-A1-0406-03
2000, 2100, 2600	 WES 304S	4-9/32" x 65'	WES CTL 61930-00		No Pens/Ribbons Required		
3000	 WES 115S	13-1/2" x 65'	WES CTW 63024-00	 WES 002P	PA 100082-01	Multi	WES 64-11-900V-01





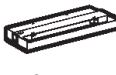

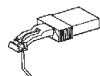









Instrument/Model No.(s) To Fit:	Chart			Our Matching Pen or Ribbon			
	Format	Size	Order By Number	Key	P/N	Color	Order By Number
Westronics [Continued] 3200	 WES 215S	13-1/2" x 65'	WES CTP 63656-00	 WES 002P	PA 100082-01	Multi	WES 64-11-900V-01
4000/4200	 WES 112S	12-3/8" x 65'	WES CTU 62960-00	 WES 094P	RM 100170-01 RM 100171-01 RM 100172-01 RM 100173-01 RM 100174-01	Red Blue Green Purple Black	WES 82-94-1012-01 WES 82-94-2013-01 WES 82-94-3014-01 WES 82-94-4016-01 WES 82-94-0011-01
Yokogawa AR 1200, 1600; ORM 1200, 1300, 1400; ORP 1200, 1300, 1400	 YOK 020S	210mm x 50M	B9879 AJ	 Black Image No Pen/Ribbon Required			
CR 1200	 PW 110C	10"	PW 00215201 (M1122 JH)	Please call us for your specific application.			
	 PW 111C	11"	PW 00215204 (M 1122JL)				
	 PW 112C	11-7/8"	PW 00215208 (M 1122JQ)				
HR 1300	 YOK 018S	230mm x 20M	YOK B9855 AY	 YOK 014P	B9627 AZ	Multi	YOK 64-11-500V-01
HR 2300, HR 2400, 4802 Hybrid	 YOK 017S	342mm x 30M	YOK B9627 AY YOK B9627 RY				











Fanning Fan-Folded Charts









The manufacturing processes involved in cross-perforating and folding a chart cause microscopic paper fibers to entwine and, sometimes, lock chart pages together. Fanning a chart pack before installing it into the recorder relieves this potential cause of jamming. To remind the user of the importance of an error-free recording run, Graphic Controls prints this notice on the package of all its manufactured fan-fold products.

Instrument/Model No.(s) To Fit:	Chart			Our Matching Pen or Ribbon			
	Format	Size	Order By Number	Key	P/N	Color	Order By Number
Yokogawa (Continued) LR 4100, LR 4200, LR 4210	 YOK 015S	270mm x 20M	YOK B9619 AH	 YOK 028P 6 Pack: YOK 020P	B9586 YA* B9586 YB* B9586 YC* B9586 YD* B9586 YE* B9586 YF* B9586 YG* B9586 YH* B9586 YS*	Red	YOK 64-28-0102-03
	 YOK 015S		YOK B9622 AH			Green	YOK 64-28-0104-03
LR 8100	 YOK 016S	270mm x 30M	YOK B9585 AH	 YOK 021P	B9585 SH	Black	YOK 64-11-800V-01
OR 1400	 YOK 022S	210mm x 40M	YOK B9987 AL		Black Image No Pen/Ribbon Required		
OR 2300, 2300A	 YOK 023S	387mm x 100M	YOK B9886 AJ				
	 YOK 021S		YOK B9886 AH				
SRHD	 YOK 003S	113mm x 8M	YOK E9721 NA	 YOK 018P	E9721 PA/PE E9721 PB/PF E9721 PC/PG E9721 PD/PH	Black Red Blue Green	YOK 64-18-0101-03 YOK 64-18-0102-03 YOK 64-18-0103-03 YOK 64-18-0104-03
μR100, μR 100F, 4151, 4152, 4153	 YOK 004S	113mm x 16M	YOK B9565 AW	 YOK 010P	B9565 AP B9565 AQ B9565 AR	Red Green Blue	YOK 82-24-0302-03 YOK 82-24-0204-03 YOK 82-24-0103-03
				 YOK 009P	B9565 AS	Plotter Pen Violet	YOK 82-24-0406-03
				 YOK 015P	B9901 AX (B9566 DZ)	Multi	YOK 64-11-700V-01
μR 100, μR 100T, ER 100	 YOK 003S	113mm x 8M	YOK E9721 NA	 YOK 027P	B9588 AY B9588 KG B9588 KH B9588 KJ	Violet Red Green Blue	YOK 64-27-0406-03 YOK 64-27-0302-03 YOK 64-27-0204-03 YOK 64-27-0103-03

* Y= STD Speed

Instrument/Model No.(s) To Fit:	Chart			Our Matching Pen or Ribbon			
	Format	Size	Order By Number	Key	P/N	Color	Order By Number
Yokogawa (Continued) μR180, μR 180T, ER 180, 4171, 4172, 4173	 YOK 007S	200mm x 20M	YOK B9573 AN	 YOK 010P	B9565 AP B9565 AQ B9565 AR	Red Green Blue	YOK 82-24-0302-03 YOK 82-24-0204-03 YOK 82-24-0103-03
				 YOK 009P	B9565 AS	Plotter Pen Violet	YOK 82-24-0406-03
				 YOK 012P	B9906 JA (B9673 RR)	Multi	YOK 64-11-200V-01
μR250, ER 250, HR 2500E, 3081,3088, 4081, 4088 Hybrid, 4181, 4182, 4183	 YOK 013S	344mm x 20M	YOK B9538 RN	 YOK 010P	B9565 AP B9565 AQ B9565 AR	Red Green Blue	YOK 82-24-0302-03 YOK 82-24-0204-03 YOK 82-24-0103-03
				 YOK 009P	B9565 AS	Plotter Pen Violet	YOK 82-24-0406-03
				 YOK 013P YOK 003P	B9538 JZ B9541 AT	Multi Multi	YOK 64-11-300V-01 YOK B9541 AT (64-11-400V-01)
μR 1000	 YOK 004S	113mm x 16M	YOK B9565 AW	 YOK 042P	B9902 AM B9902 AN B9902 AP B9902 AQ	Red Green Blue Violet	YOK 64-42-0102-03 YOK 64-42-0204-03 YOK 64-42-0303-03 YOK 64-42-0406-03
				 YOK 042P	B9902 AR	Plotter Pen Purple	YOK 64-42-0506-03
				 YOK 015P	B9901 AX	Multi	YOK 64-11-700V-01
μR 1800	 YOK 007S	200mm x 20M	YOK B9573 AN	 YOK 042P	B9902 AM B9902 AN B9902 AP B9902 AQ	Red Green Blue Violet	YOK 64-42-0102-03 YOK 64-42-0204-03 YOK 64-42-0303-03 YOK 64-42-0406-03
				 YOK 042P	B9902 AR	Plotter Pen Purple	YOK 64-42-0506-03
				 YOK 012P	B9906 JA	Multi	YOK 64-11-200V-01





Instrument/Model No.(s) To Fit:	Chart			Our Matching Pen or Ribbon			
	Format	Size	Order By Number	Key	P/N	Color	Order By Number
Yokogawa (Continued) 3021	 YOK 011S	280mm x 15M	YOK B9531 AY (3045-15)	 YOK 019P	B9518 CS (B9549 LS)	Black	YOK 64-19-0101-03
	 YOK 011S	280mm x 20M	YOK B9531 AZ (3045-16)		B9518 CT B9518 CU B9518 CV	Red Green Blue	YOK 64-19-0102-03 YOK 64-19-0104-03 YOK 64-19-0103-03
3022	 YOK 002R	210mm x 297mm DIN A4	YOK B9523 VQ (3084-11)				
3023, 3024, 3033, 3036	 YOK 011R	296mm x 420mm DIN A3	YOK B9526 AW (3084-12)				
	 YOK 010S	270mm x 15M	YOK B9523 BH (3084-02)				
3025	 YOK 008S	210mm x 15M	YOK B9523 VY (3084-03)				
	 YOK 002R	210mm x 297mm DIN A4	YOK B9523 VQ (3084-11)				
3046/3056	 YOK 010S	270mm x 15M	YOK B9501 AH/NN (3045-04)				
3047/3057	 YOK 006S	174mm x 15M	YOK B9529 AA/CC (3045-13)				
	 YOK 006S	174mm x 20M	YOK B9529 AB/AD (3045-14)				







Instrument/Model No.(s) To Fit:	Chart			Our Matching Pen or Ribbon			
	Format	Size	Order By Number	Key	P/N	Color	Order By Number
Yokogawa (Continued) 3063/3066	 YOK 006S	270mm x 15M	YOK B9501 AH/NN (3045-04) (XT-127)	 YOK 019P	B9518 CS (B9549 LS)	Black	YOK 64-19-0101-03
	 YOK 010S	270mm x 20M	YOK 3045-05		B9518 CT B9518 CU B9518 CV	Red Green Blue	YOK 64-19-0102-03 YOK 64-19-0104-03 YOK 64-19-0103-03
3086	 YOK 008S	270mm x 20M	YOK 9523 VY (3084-03)				
3087 Portable Hybrid	 YOK 009S	210mm x 17M	YOK B9541 AR (3045-41)	 YOK 003	B9541 AT	Multi	YOK B9541 AT (64-11-400V-01)
3655/3656 Analyzing Recorder	 YOK 014S	264mm x 20M	YOK B9708 PA	 YOK 043P	3659-81 3659-82 3659-83 3659-84	Black Red Green Blue	YOK 64-10-0501-04 YOK 64-10-0502-04 YOK 64-10-0503-04 YOK 64-10-0504-04



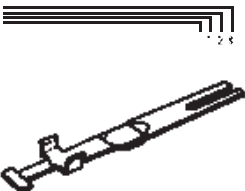

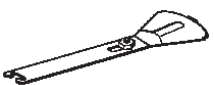
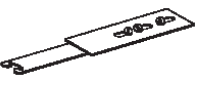

Innovative
**Low-Lean
 Paper**

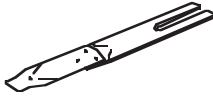

In response to the tight tolerances required of the newer hybrid recorders, we have worked closely with our suppliers to develop a Low-Lean paper. This fanfold paper minimizes the lean or twist that may be experienced with changes in temperature and/or humidity, thereby reducing the risk of paper jams.

Accessories for Recording Supplies









Instrument/Model No.(s) To Fit:	Sketch	Description	Mfr. Replacement Part No.	Position/Color	Order By Number
Bailey Controls C,D,K,L	 BA 031P	Pen Arm Replacement for use with Series 39 & Series 76 Disposable Pen Arms Adjustable Length	35705-1, 2, 3 & 4		BA 80-36-3320-01 1 per package
KM55 & WM55	 BA 031P	Pen Arm Replacement for use with Series 76 Disposable Pen Arms	35308A1/1948561A5 35308A2/1948561A6 35308A3/1948561A7 35308A4/1948561A8	Outer Inner	BA 80-36-3240-01 BA 80-36-3250-01 BA 80-36-3260-01 BA 80-36-3270-01 1 per package
	 BA 030P	Pen Arm Replacement for use with Series 39 Disposable Pen Arms - Adjustable Length	35308A1 35308A2 35308A3 35308A4		BA 80-36-2110-01 BA 80-36-2100-01 BA 80-36-2090-01 BA 80-36-2080-01 1 per package
Bristol To Fit 8" Circular Recorders ITIOT169		-	-	#1	BR 80-36-1640-01
530	 BR 030P	-	-	#1 #2	BR 80-36-1670-01 BR 80-36-1680-01
532		-	-	#1 #2	BR 80-36-1280-01 BR 80-36-1680-01
541 Voltage Meter & Amperage Meter		Lightweight, for Series 22 disposable pens	-	#1 #2	BR 80-36-3010-01 BR 80-36-3020-01
565, 575, 680, 682, 685		-	-	#1	BR 80-36-1070-01
4069TH		-	-	#1 #2	BR 80-36-1640-01 BR 80-36-1650-01







Instrument/Model No.(s) To Fit:	Sketch	Description	Mfr. Replacement Part No.	Position/Color	Order By Number
Bristol (Continued) To Fit 12" Circular Recorders 500, 501, 681, 683, 4331	 BR 030P	-	-	#4	BR 80-36-1050-01
		-	-	#1	BR 80-36-1010-01
		-	-	#2	BR 80-36-1020-01
541 Ammeter & Voltmeter	BR 030P	-	-	#1, #2, #3	BR 80-36-1280-01
560, 570, 590		-	-	#1	BR 80-36-1070-01
500, 501, 681, 683, 4331	 BR 032P	Adjustable Length Replaces fixed length 80-36-1010-01, 80-36-1020-01, 80-36-1030-01	-	#1, #2, #3	BR 80-36-3230-01
Foxboro Din Recorders, E27R, 126, 127, 226, 227, 760R	 FX 036P	Harp Style	D0129ZR		FX 80-36-1930-04
	 FX 036P	Rectangular Style	D0129ZX		FX 80-36-1920-04
GAP-3, 10RD 10"	 FX 031P	Adjustable Length	-		FX 80-36-2420-01
30, 40, 740 12"	 FX 031P	Adjustable Length	-		FX 80-36-2410-01
	 FX 032P	Fixed Length	MO-122-AA MO-122-AB MO-122-AD		FX 80-36-1220-01 FX 80-36-1210-01 FX 80-36-1200-01
Hagan/Westinghouse/C.C.D./ Rosemount Ring Balance Meters 2000, 3000, 4000, 5000, 6000 (12")	 WE 030P	For use with Universal Series 39 Disposable Pens	170082-1 170082-2 170082-3 170082-4	Red Blue Green Purple	WE 80-36-1450-01 WE 80-36-1440-01 WE 80-36-1420-01 WE 80-36-1430-01

Instrument/Model No.(s) To Fit:	Sketch	Description	Mfr. Replacement Part No.	Position/Color	Order By Number
Hagan/Westinghouse/C.C.D./ Rosemount (Continued)	 WE 037P	For use with Universal Series 76 Disposable Pens	170082-1 170082-2 170082-3 170082-4		WE 80-36-3630-01
Optimac (4") Strip, Optimac 100, 300	 MP 021P	Ink Cartridge 2.6 cc	170085-1 170085-2 170085-3 170085-4	Red Blue Green Purple	MP 81-10-0012-04A MP 81-10-0013-04A MP 81-10-0014-04A MP 81-10-0016-04A
Honeywell Strip	 BN 022	3.2 cc Turret Ink Cartridge	30730652-001 30730652-002 30730652-003	Purple Red Green	BN 81-14-0036-04 BN 81-14-0032-04 BN 81-14-0034-04 Four Ink Cartridges per package
	 BN 021	3.5 cc Turret Ink Cartridge	30682002-001 30682002-002 30682002-003	Red Blue Green	BN 81-14-0142-04 BN 81-14-0143-04 BN 81-14-0144-04 Four Ink Cartridges per package
Circular Recorders	 MP 021	2.6 cc Cylinder Cartridge Slow Drying	661715-3 661715-4 661715-2 661715-1	Red Blue Green Purple	BN 81-10-0012-04A BN 81-10-0013-04A BN 81-10-0014-04A BN 81-10-0016-04A Four Ink Cartridges per package
Class 15	 BN 036	Adapter Bracket Converts remote reservoir inking systems only	49788557-001		#1 Single BN 80-55-2130-03 3 Adapters per package

Instrument/Model No.(s) To Fit:	Pen Arm Sketch	Mfr. Replacement Part No.	Order By No.	Mfr. Replacement Part No.*	Pen Sketch	Position/Color	Order By Number
Honeywell Class 22, 45, 60, 70 (Rect. Case) Single Pen	 BN 030P	30735442-001	BN 80-36-1760-01	P 30735441-001 P 30735489-001 P 30735490-001	 MP 012P	#1 Single Purple	MP 82-39-0206-06
Two Pen		30735442-001 30735442-002	BN 80-36-1760-01 BN 80-36-1770-01	P 30735489-001 P 30735489-006		#1 Purple #2 Green	MP 82-39-0206-06 MP 82-39-0304-06
Two Pen with cam control		30735442-001 30735442-002	BN 80-36-1760-01 BN 80-36-1770-01	P 30735489-005 P 30735489-003		#1 Red #2 Green	MP 82-39-0102-06 MP 82-39-0204-06
Three Pen		30735442-002	BN 80-36-1770-01	P 30735489-001 P 30735489-006 P 30735489-005		#1 Purple #2 Green #3 Red	MP 82-39-0206-06 MP 82-39-0304-06 MP 82-39-0102-06
Class 152, Single Pen		30735442-007	BN 80-36-1800-01	P 30735489-001		#1 Purple	MP 82-39-0206-06

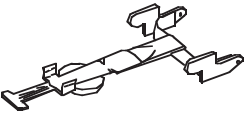
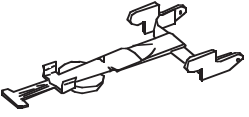
* Honeywell uses three different part number series for circular pens.

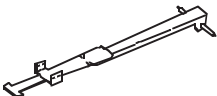
Instrument/Model No.(s) To Fit:	Sketch	Description	Mfr. Replacement Part No.	Position/Color	Order By Number
Leeds & Northrup Speedomax H Model "S"	 LS 137P	Pen Holder	054367		LS 80-36-0480-01
Moore Products 362 and 5300 Series	 ME 002P	Ink Cartridge 4 per pack	14230-424/274 14230-425/273 14230-426/275 15747-29	Red ME 81-04-0012-04 Blue ME 81-04-0013-04 Green ME 81-04-0014-04 Orange ME 81-04-0017-04	
Older Models	 MP 021P		10700-183-S 10700-184-S 10700-185-S	Red MP 81-10-0012-04A Blue MP 81-10-0013-04A Green MP 81-10-0014-04A	
	 FRP 020P		10752-320-S 10752-321-S 10752-322-S	Red FRP 81-19-0012-04A Blue FRP 81-19-0013-04A Green FRP 81-19-0014-04A	
Motorola/Westinghouse/ C.C.D./Rosemount 55R, 56R Veritak	 WE 038P	Pen Arm Adapter	—	Green WE 80-36-3930-01 Red WE 80-36-3940-01 Blue WE 80-36-3950-01	
Partlow LF, MF, MRC 7000, RF	 PW 030P	Pen Arm	—		PW 80-36-3720-01
United Electric Controls	 UD 030P	Pen Arm for 10" Circular Charts	6219-504		UD 80-36-2290-01
Weksler 6"	 HT 031P	Pen Arm	—		HT 80-36-3220-01
8"	 BR 030P	Pen Arm	—		BR 80-36-1640-01

Instrument/Model No.(s) To Fit:	Sketch	Description	Mfr. Replacement Part No.	Position/Color	Order By Number
Weksler (Continued) 10"	 MP 031P	#1 Pen Arm	-		MP 80-36-2210-01
	 BR 030P	#2 Pen Arm		BR 80-36-1670-01	
		#3 Pen Arm		BR 80-36-1070-01	
		#4 Pen Arm		BR 80-36-1680-01	
12"	 PW 030P	#1-4 Pen Arms	-		PW 80-36-3720-01
Weschler Instruments Type A (7")	 WE 031P	V Pen Assembly	718846		WE 80-36-2160-01
Type A Ammeter		Glass Pen Assembly	1063637		
Type A Voltmeter	 WE 031P	Glass Pen Kit	1155919		WE 80-36-2160-01
	 WE 032P	Balance Weight*	1095900		WE 80-09-0220-10
Type 45 (7")	 WE 029P	Pen Arm	629A974G01		WE 80-36-2150-01
Westinghouse/C.C.D./ Rosemount G40 Optimac	 MP 021P	2.6cc Ink Cartridge	170085-1 170085-2 170085-3 170085-4	Red Blue Green Purple	MP 81-10-0012-04A MP 81-10-0013-04A MP 81-10-0014-04A MP 81-10-0016-04A

* Replacement of V Pen requires both Arm and Balance Weight.
When replacing Glass Pen Assembly, only the Pen Arm is required, Balance Weight should already be installed.

dataGRAPHIC®

Non-Impact
Recording Papers
and
Films

.....
Industrial Monitoring Solutions

Use our quality thermal, electrosensitive, dielectric or non-photographic coated recording media for computer hard copy printers, analytical graphic printers, depth recording and process dataloggers. Some of our more popular items are listed here; if you need help - call us! We're here to help identify a solution for you.

Instrument/Model No. (s) To Fit:	Graphic Controls Equivalent	Reorder/ Part Number	Size W x L	Media Type/ Trace	Wound	Roll Diameter	Core ID	Price Code
AVL AVL 985-S	BMI 6402	01051127	1.5" x 30'	HS Black	Out	N/A	(coreless) 0.250"	BMI 301
Air Shield Plain Roll	PPR AIR PPR2550	30934411	2.375" x 55'	ES Metallized	Out	N/A	0.500"	PPR 248
Allied Signal 8050917	PNR 8050917-0002	31107512	111mm x 20M	HS Black	Out	2"	0.500"	PNR 003
Ames Plain Roll	PPR AM PPR8080B	30911088	4.25" x 85'	HS Black	Out	N/A	0.438"	PPR 002
Axiom EX-401A, EX-401B	AXM EX-800	01009976	5" x 200'	ES Metallized	In	N/A	0.480"	AXM 005
EX-801, EX-820 EX-850, EX-885	AXM ESP-252	10017870	5" x 230'	ES Metallized	In	N/A	1.000"	AXM 005
TX-500	AXM TX-500	30546967	127mm x 132'	HS Black	Out	N/A	1.000"	AXM 304
TX-1000	AXM TX-1000	01116086	8.47" x 200'	HS Black	Out	3.1"	1.000"	AXM 008
TX-2000	AXM TX-2000							
Barber Colman Data Pro	BC 19-2046	10133388	2.375" x 63'	HS Blue	Fan Fold	136 sheets	5.5" perf/fold	BC 302
Basic Measuring Instruments (BMI) 100G	BMI 900111043	30967841	113mm x 200'	HS Black	Out	3.0"	0.500"	BMI 305
2400	BMI 2400	30765922	2.343" x 98'	HS Black	Out	2.063"	0.472"	BMI 002
3030	BMI 90111041	30910726	2.313" x 100'	HS Black	Out	N/A	0.500"	BMI 005
4800	BMI 72330001	30911518	108mm x 400'	HS Black	Out	N/A	0.438"	BMI 250
	BMI 90111040							
Baxter Stratus	DIG 19-19496	10420744	60mm x 100'	HS Blue	Out	N/A	0.500"	DIG 302
Stratus II	GPS FTP-040P001	30859071	4.3" x 82'	HS Black	Out	N/A	0.500"	GPS 304
Beckman 42, E2A, E4, E4A, EC-4, LS1800	PPR PPR 2090A	30909686	2.5" x 165'	HS Black	Out	N/A	0.500"	PPR 200
Appraise	PPR PPR 3210B	30910064	4.313" x 135'	HS Black	Out	2.4"	0.515"	PPR 163
DO-5	PPR PPR 2440A	30909223	2.25" x 80'	HS Blue	Out	N/A	0.625"	PPR 201
Omniprint 426	PPR PPR 3210B	30910064	4.313" x 135'	HS Black	Out	2.4"	0.515"	PPR 163
Bosch RMP 8146	BOS 0674, 007, 001	20140515	60mm x 98'	ES Metallized	Out	N/A	0.472"	BOS 002
	BOS 0674, 007, 002	10861533	5" x 164'				0.625"	BOS 005
Thermal	BOS 6 786 753 146	30627411	144mm x 100'	HS Black	In	2.031"	0.625"	BOS 009

ES = Electrosensitive
HS = Heat Sensitive

Instrument/Model No.(s) To Fit:	Graphic Controls Equivalent	Reorder/ Part Number	Size W x L	Media Type/ Trace	Wound	Roll Diameter	Core ID	Price Code
Brinkman 658KF	BRK 6, 2237,000	30561966	210mm x 197'	HS Black	Fan Fold	200 sheets	300mm perf/fold	BRK 307
Brush 297500	BSH 297500	30911666	4.469" x 82'	HS Black	Out	N/A	0.500"	BSH 252
Datel APP-20	DDT 58-9374-1	10149848	2.25" x 145'	HS Blue	Out	2.5"	0.470"	DDT 302
	DDT 58-9374-1 BK	10522796		HS Black				
APP-20E2	PNR NO 269	30776853	58mm x 130'	HS Black	Out	2.438"	0.438"	PNR 269
APP-48	DDT 32-9469-1	01156256	5" x 150'	HS Blue	Out	2.5"	0.480"	DDT 305
CDPP-07	DDT 9114	10149814	1.75" x 150'	HS Black	Out	2.5"	0.450"	DDT 301
Digitec 2000, 3000, 6400, 6430 6510, 6520	DIG 19-18592	10726611	60mm x 100"	ES Metallized	Out	N/A	0.500"	DIG 004
6470, 6550, 6560	DIG 19-19496	10420744	60mm x 100'	HS Blue	Out	N/A	0.500"	DIG 302
		DIG 19-20171		10420793				
Doric 205	DOC 205B-PPR2	30587946	2.25" x 260'	HS Black	Fan Fold	567 sheets	5.5" perf/fold	DOC 301
Dragnetz GP626	PPR DRZ PPR6050B	30945870	4.406" x 80'	HS Black	Out	1.9"	0.500"	PPR 020
616	DRZ 102714	10244672	2.25" x 150'	HS Blue	Out	N/A	0.453"	DRZ 001
626	DRZ 110888C	30638897	111mm x 80'	HS Black	Out	1.875"	0.468"	DRZ 311
8000	DRZ Model 8000	31099578	60mm x 80'	HS Black	Out	48mm	0.500"	DRZ 097
Various	DRZ PPR9150B	30981321	60mm x 95'	HS Black	Out	N/A	0.500"	DRZ 302
Dupont ACA IV	GI D20M	10124353	2.25" x 150'	HS Black	Out	2.5"	0.470"	GI 302
	GI D20N	10124361		HS Blue				
ACA-5	GI D44M	10692771	4.969" x 150'	HS Black	Out	2.469"	0.480"	GI 305
		GI D44N		10112457				
Echometer Model D	PPR ECH 08256	30909348	1.75" x 125'	HS Blue	In	N/A	0.625"	PPR 015
New Model	PPR ECH NEW	Call	1.75" x 75'	HS Blue	In	N/A	0.625"	Call
Energy Efficiency System Plain Roll	PPR EES 6030B	30930849	79mm x 80'	HS Black	Out	N/A	0.500"	PPR 248
Epson P-40	EPN P40TRP	10636364	4.375" x 30'	HS Black	Out	1.188"	coreless	EPN 304

ES = Electrosensitive
HS = Heat Sensitive

Instrument/Model No. (s) To Fit:	Graphic Controls Equivalent	Reorder/ Part Number	Size W x L	Media Type/ Trace	Wound	Roll Diameter	Core ID	Price Code
Fluke								
1275	FLU 1275	10456524	3.5" x 230'	Inkwriting 1.9mil	Fan Fold	500 sheets	5.5" perf/fold	FLU 003
2020A, 2021A, 2030A	FLU Y2035	10373604	2.438" x 235'	HS Black	Out	N/A	0.450"	FLU 002
2280A	FLU 631853	30644523	110mm x 120'	HS Black	Out	2.313"	0.470"	FLU 304
7013 Thermal	FLU 7013	10779065	2.25" x 275'	Inkwriting 1.9mil	Fan Fold	600 sheets	5.5" perf/fold	FLU 001
Frisco Bay								
Plain roll	PPR FB PPR 7340B	30910718	2.25" x 400'	HS Black	Out	N/A	0.625"	PPR 020
Fujitsu								
FTP-040MCS, FTP-040UCS	GPS FTP-040P001	30859071	4.3" x 82'	HS Black 616	Out	N/A	0.500"	GPS 304
FTP-040MCS001	GPS FTP-040P	30910817	109mm x 100'	HS Black 929	Out	N/A	0.625"	GSP 040
Various	GPS FTP-040P0020	31040101	4.469" x 98'	HS Black 304	Out	2.203"	0.437"	GPS 097
Gem Sensor Systems								
6 - Analyzer	SKO TP201-211-25	30603925	2.25" x 80'	HS Black 616	Out	1.875"	0.480"	SKO 333
Gilford								
STASAR 3, 202, 400	HP 9270-0479	10090034	2.25" x 250'	HS Blue 44	Out	3.0"	0.470"	HP 014
Gulton								
ANP-7, NP-9	GI D6M	10089838	2" x 145'	HS Black 936	Out	2.5"	0.478"	GI 301
	GI D6N	10089986		HS Blue 44			0.470"	
AP-20, 20T	GI D20M	10124353	2.25" x 150'	HS Black 936	Out	2.5"	0.478"	GI 302
	GI D20N	10124361		HS Blue 44			0.470"	
CompuTrak 610	GI D44ZM	20917540	5" x 70'	HS Black 616	Fan Fold	213 sheets	100mm perf/fold	GI 307
Micro D44M, Micro P44M	GI D44M	10692771	4.969" x 150'	HS Black 616	Out	2.469"	0.480"	GI 305
Micro D44N, Micro P44N	GI D44N	10112457	4.969" x 150'	HS Blue 44	Out	2.469"	0.480"	GI 305
Micro P44L, 44-L, 44-T	GI D44M	10692771	4.969" x 150'	HS Black 616	Out	2.469"	0.480"	GI 305
	GI D44N	10112457	4.969" x 150'	HS Blue 44	Out	2.469"	0.480"	GI 305
MT-80T, 80-T	GI D80M	01031384	8.75" x 150'	HS Black 936	Out	N/A	0.468"	GI 308
	GI D80M 100FT	30962909	8.75" x 100'			1.95"		GI 319
Well Logger	PPR GUL 308-0002	30911930	12" x 300'	HS Black 936	Out	3.5"	0.500"	PPR 316
Halton								
Refund Receipt	PPR HA REFUND	30920287	72mm x 210'	HS Black 929	Out	75mm	0.472"	PPR 028
Hioki								
8801, 8802, 8802-01, 8810	HIO 9221	20046290	110mm x 98'	HS Black 616	Out	N/A	0.500"	HIO 306
ES Printer	HIO 9073	01246107	69.5mm x 33'	ES Metallized 97	Out	N/A	0.404"	HIO 005
Various	HIO 9229 PPR	30967973	10.344" x 90'	HS Black 304	Out	N/A	0.468"	HIO 308
	HIO 9229	31110516	264mm x 99'				0.640"	HIO 310

ES = Electrosensitive
HS = Heat Sensitive

Instrument/Model No.(s) To Fit:	Graphic Controls Equivalent	Reorder/ Part Number	Size W x L	Media Type/ Trace	Wound	Roll Diameter	Core ID	Price Code
Houston 6000	HI RC-3039	10513431	245mm x 88'	HS Black 945	Out	N/A	0.755"	HI 309
Hybritech Photon II	SKO TP401-25	30749462	80mm x 80'	HS Black 616	Out	1.9"	0.472"	SKO 313
Hewlett-Packard Gas Chromatograph P150, 125, 2673, 2674A	HP 5062-3561	30761822	9.5" x 2292'	Ink Jet Paper 100	Fan Fold	2500 sheets	11" perf/fold	HP 015
	HP 92160A	10794429	8.5" x 100'	HS Blue 44	Out	N/A	0.480"	HP 328
	HP 92160B	20269637		HS Black 603				HP 341
	HP 92160C	10282110						11" perf/fold
Thinkjet	HP 92261A	01154434	Ink Jet Cartridge	Black Monochrome	-	-	-	HP 002
	HP 92261N	01123744	9.5" x 2292'	Ink Jet Paper 100	Fan Fold	2500 sheets	11" perf/fold	HP 022
97A, 3075A, 3076A, 3077A, 82143A, 82162A	HP 82045A	10149780	2.25" x 80'	HS Blue 44	Out	N/A	0.470"	HP 304
	HP 82175A	01034081		HS Black 627				HP 352
1080, 3380A, 3380S, 3385A, 5830A, 5840A	HP 5080-8735 BLACK	10645035	8.422" x 184'	HS Black 936	Fan Fold	200 sheets	11" perf/fold	HP 331
	HP 5080-8735 BLUE	00813360		HS Blue 44				HP 007
2671A, 2671G	HP 92160A	10794429	8.5" x 100'	HS Blue 44	Out	N/A	0.480"	HP 328
	HP 92160B	20269637		HS Black 603				HP 341
	HP 92160C	10282110						11" perf/fold
	HP 92160M	10751882	8.5" x 302'	HS Blue 44	Fan Fold	330 sheets	11" perf/fold	HP 338
	HP 92160N	10751874		HS Black 603				HP 337
2673A	HP 92160M	10751882	8.5" x 302'	HS Blue 44	Fan Fold	330 sheets	11" perf/fold	HP 338
	HP 92160N	10751874		HS Black 603				HP 337
3075A, 3076A, 3077A, 82143A, 82162A	HP 82045A	10149780	2.25" x 80'	HS Blue	Out	N/A	0.470"	HP 304
	HP 82175A	01034081		HS Black				HP 352
5880	HP 5080-8735 BLACK	10645035	8.422" x 184'	HS Black 936	Fan Fold	200 sheets	11" perf/fold	HP 331
	HP 5080-8735 BLUE	00813360		HS Blue 44				HP 007
	HP 9270-0625 CD937	00991497		HS Blue 44				HP 319
	HP 9270-0625	00991489		HS Black				HP 378
9876A	HP 9270-0640	10321769	8.5" x 302'	HS Black	Fan Fold	330 sheets	11" perf/fold	HP 047
Hommel Plain Roll	PPR HML PPR7890B	30911310	2.828" x 68'	HS Black	Out	N/A	0.472"	PPR 031
Hycom DC-004	PPR PPR1740	30911534	120mm x 131'	ES Metallized	Out	N/A	1.000"	PPR 187
DC-1606D, DC-2106D	LS 005910	00980011	2.25" x 110'	ES Metallized	Out	N/A	1.000"	LS 018
Instrument Labs Plain Roll	PPR INL80075-04	30911237	2.719" x 85'	HS Black	Out	N/A	0.500"	PPR 036
IRD Mechanalysis 820, 880	IRD 24444	01159946	2.25" x 80'	HS Black	Out	1.9"	0.470"	IRD 302

ES = Electrosensitive
HS = Heat Sensitive

Instrument/Model No. (s) To Fit:	Graphic Controls Equivalent	Reorder/ Part Number	Size W x L	Media Type/ Trace	Wound	Roll Diameter	Core ID	Price Code
Kajani FS-200	PPR KAJ 202176	30911559	129mm x 82'	HS Black	Out	N/A	0.421"	PPR 067
Leeds & Northrup Trendscan	LS 005910	00980011	2.25" x 110'	ES Metallized	Out	N/A	1.000"	LS 018
Lohata Plain Roll	PNR TP112L	31020772	110mm x 112'	HS Black	Out	N/A	0.500"	PNR 001
Madsen 5000 110	PPR PPR3240A	30911484	110mm x 115'	HS Blue	Out	N/A	0.470"	PPR 159
Z0174	PPR MA PPR3240B	30919529	110mm x 115'	HS Black	Out	N/A	0.470"	PPR 070
Mahr Perthner Plain Roll	PPR MHP PPR7850B	30911674	120mm x 328'	HS Black	In	N/A	0.625"	PPR 073
	PPR MHP PPR7860B	30934650	4.5" x 57'			1.575"	0.406"	PPR 212
Maico MA728	PPR MAI PPR7560B	30911302	62.5mm x 230'	HS Black 936	Out	N/A	0.500"	PPR 071
Memodyne M2 Series	MDE PT-L6	30790060	4.375" x 955'	HS Black 627	Out	6.0"	0.450"	MDE 304
M234	MDE PT-401	31102901	4.33" x 94'	HS Black 603	Out	2.05"	0.450"	MDE 303
M4 Series	MDE PT-20B1	01128610	2.297" x 94'	HS Black 627	Out	N/A	0.438"	MDE 302
Metrohm 658KF 672 Titroprocessor	PPR MET 6.2237.020	30910239	2.25" x 100'	HS Black 304	Out	N/A	0.437"	PPR 072
Mettler 6A40	PNR NO 157	10687870	2.25" x 80'	HS Blue 44	Out	1.938"	0.470"	PNR 157
6A44	SKO TP201-211-25	30603925	2.25" x 80'	HS Black 616	Out	1.875"	0.480"	SKO 333
Microbill 1000	TX 972603	10794734	8.5" x 95'	HS Black 29	Out	N/A	0.437"	TX 108
2000, 3000	PAN KDX-24	10674506	8.5" x 100'	HS Black 616	Out	N/A	0.437"	PAN 306
Miltope 463797-15	MIP 463797-15	-	107mm x 66'	HS Black 304	Out	2.0"	0.500"	MIP 003
471386-1	MIP 471386-1	31113015	113mm x 20m	HS Black 304	Out	5cm	0.500"	MIP 003
705822-111	MIP 705822-111	31082889	8.469" x 122'	HS Black 304	Out	2.25'	0.480"	MIP 097
Minolta CR-200	PPR MIN DP-A21	30909413	2.25" x 28'	HS Black 304	Out	1.25"	0.437"	PPR 075
Mitsubishi Video K-50	VPPR VID K-50	30912763	110mm x 82'	HS Black 304	Out	2.0"	0.508"	PPR 050
Various Models	PPR PPR 3400B	30910676	110mm x 82'	HS Black 608	Out	N/A	0.470"	PPR 238

ES = Electrosensitive
HS = Heat Sensitive

Instrument/Model No.(s) To Fit:	Graphic Controls Equivalent	Reorder/ Part Number	Size W x L	Media Type/ Trace	Wound	Roll Diameter	Core ID	Price Code
3M								
Pyxis	PNR PYXIS	31071676	4.313" x 100'	HS Black 603	Out	N/A	0.450"	PNR 002
Whisper Writer	MMM 78-6145-9005-3	10794536	4.438" x 80'	HS Black 29	Out	N/A	0.450"	MMM 304
	MMM 78-6145-9001-2	10794502	8.469" x 80'	HS Black 616			0.437"	MMM 308
1440, 1441, 1462, 1902, 1904	MMM 78-6145-9005-3	10794536	4.438" x 80'	HS Black 29	Out	N/A	0.450"	MMM 304
1480, 1481, 1482, 1912, 1914	MMM 78-6145-9001-2	10794502	8.469" x 80'	HS Black 616	Out	N/A	0.437"	MMM 308
Ortho								
16-S Koagulab	ORH FTP-020P011	30909926	60mm x 100'	HS Black 929	Out	N/A	0.500"	ORH 011
Panasonic								
EUY 2T	BMI 6402	01051127	1.5" x 30'	HS Black 616	Out	N/A	(coreless) 0.250"	BMI 301
EUY 3T	PAN EUY-3T	01039759	80mm x 100'	HS Black 603	Out	N/A	0.472"	PAN 003
KX-D 4900 et al	PAN KDX-24	10674506	8.5" x 100'	HS Black 616	Out	N/A	0.437"	PAN 306
Perkin Elmer								
GC	PR 332-1911	10659986	8.5" x 184'	HS Black 936	Fan Fold	200 sheets	11" perf/fold	PR 015
Plain Film Thermal Printer Rolls*								
Plain Roll	CNR 57MMX69FT	31024386	57mm x 69'	HS Black Film 38	Out	N/A	0.500"	CNR 302
	CNR 57MMX30M	30665361	57mm x 30m					CNR 312
	CNR 62MMX30M	30740990	62mm x 30m					CNR 305
	CNR 72.3MMX69FT	31068243	72.3mm x 69'				0.625"	CNR 304
	CNR 80MMX69FT	31024394	80mm x 69'				0.437"	CNR 300
	CNR 110MMX69FT	30992393	110mm x 69'				0.500"	CNR 304
Printrex								
820/822	PNR PRINTEX 2316-0001	31036083	8.703" x 130'	HS Black	Out	2.313"	0.468"	PNR 319
	PNR PRINTEX 820	31117974	8.7750" x 130'					PNR 007
Radiometer								
ABL-30	RMR 984-051	30910031	60mm x 100'	HS Black	Out	2.078"	0.472"	RMR 006
ABL-330	PPR PPR2040A	30922564	60mm x 100'	HS Black	Out	N/A	0.437"	PPR 126
ABL-4, ABL-500	RMR PPR8060B	30910536	4.469" x 140'	HS Black	Out	N/A	0.480"	RMR 007

ES = Electrosensitive
HS = Heat Sensitive

* **Note:** These rolls *are not* certified for clean room use as made by/shipped from Graphic Controls.

Instrument/Model No. (s) To Fit:	Graphic Controls Equivalent	Reorder/ Part Number	Size W x L	Media Type/ Trace	Wound	Roll Diameter	Core ID	Price Code
Seiko								
DPU-40	SKO TP40-20-CL	30610326	79mm x 64'	HS Black	Out	1.594"	(coreless) 0.375"	SKO 303
LTP 251, MTP 201, STP 211	SKO TP201-211-25	30603925	2.25" x 80'	HS Black	Out	1.875"	0.480"	SKO 333
LTP 451, TP411-25, TP411-451-45	SKO TP451-28	30910486	4.406" x 85'	HS Black	Out	1.875"	0.375"	SKO 028
MTP 102	SKO TP102-9	30603941	38mm x 28'	HS Black	Out	1.20"	0.433"	SKO 331
STP 411	SKO TP411-25	30594884	4.391" x 80'	HS Black	Out	N/A	0.468"	SKO 304
VP-10	PPR SIK SP1975	30911336	79mm x 55'	HS Black	Out	1.578"	0.375"	PPR 124
Video Printer	SKO TP401-25	30749462	80mm x 80'	HS Black	Out	1.90"	0.472"	SKO 313
Sharp								
ES Models	PPR PPR1740	30911534	120mm x 131'	ES Metallized	Out	N/A	1.000"	PPR 187
Shimadzu								
CR3A, SE120	SZU 221-25412	01062389	8.188" x 167'	HS Black	Out	2.640"	0.500"	SZU 307
TOC-500, 078-15006-08	PPR SHZ PPR8000B	30910304	2.25" x 110'	HS Black	Out	N/A	0.453"	PPR 249
160UV	PNR NO 202	01005958	4.33" x 150'	HS Black	Out	N/A	0.472"	PNR 202
Sony								
NP-860	TVM 110	21089090	110mm x 21m	HS Black Film	Out	N/A	0.470"	TVM 010
NP-860HD	SNY UPP-110HD	30751542	110mm x 21m	HS Black Film High Density Print	Out	N/A	0.470"	SNY 012
Spectra-Physics								
SP4000, SP4100, SP4200	SPE A0022-020	01111699	9.344" x 184'	HS Black	Fan Fold	200 sheets	11" perf/fold	SPE 309
SP4270, SP4290	SPE A2157-020	01111178	9.344" x 184'	HS Black	Out	11" x-perf	0.500"	SPE 310
Summit Avionics								
7468433	SMA 7468433	31112702	8.469" x 150'	HS Black	In	2.688"	1.000"	SMA 309
Taylor								
1700J, 30	TA 82S1	01073808	4.313" x 49'	HS Black	Out	1.50"	0.472"	TA 005
	TA 82S1 65FT	30558707	4.313" x 65'	HS Black		1.625"		TA 006
	TA 82S2 FILM	30736105	4.313" x 40'	HS Black Film		1.50"		TA 301
Taylor-Hobson								
112 Series	TH 112/2045	30717980	4.44" x 132'	HS Black	In	N/A	0.250"	TH 304
Teledyne Geotech								
Seismograph	GTH 3790	30717675	11.813" x 38"	HS Black	Sheet	-	500 shts/pk	GTH 012
	GTH 3790 SLEEVED	30959640			100 shts/slv			
Telpar								
P40	EPN P40TRP	10636364	4.375" x 30'	HS Black	Out	1.188"	coreless	EPN 304

ES = Electrosensitive
HS = Heat Sensitive

Instrument/Model No.(s) To Fit:	Graphic Controls Equivalent	Reorder/ Part Number	Size W x L	Media Type/ Trace	Wound	Roll Diameter	Core ID	Price Code
Texas Instruments								
PC 100	TX TP-30250	10149756	2.438" x 250'	HS Blue	Out	2.875"	0.450"	TX 303
703/1200, 707/1200 733/1200	TX 2248162-0001	10780766	8.469" x 100'	HS Black	Out	1.906"	0.437"	TX 308
730, 733, 735	TX 213714	10794866	8.469" x 300'	HS Black	Out	N/A	0.984"	TX 113
763, 765, 767, 769, 780 781, 783, 785, 787	TX 972603	10794734	8.5" x 95'	HS Black	Out	N/A	0.437"	TX 108
5015, 5040, 5220, 5225	TX TP-27225	10149764	2.25" x 165'	HS Blue	Out	2.75"	0.470"	TX 302
5050, 5135	TX TP-20225	10149772	2.25" x 85'	HS Blue	Out	2.0"	0.470"	TX 301
Various Models	TX 2207291-001	10958495	4.5" x 82'	HS Black	Out	2.0"	0.780"	TX 305
	TX 2207291-8001	01117258	4.484" x 75'			1.91"		
Toshiba								
738 & Hybrid	THB 3Z8A1614P018	01093418	110mm x 54'	HS Black	In	39mm	0.472"	THB 304
Various Models	THB 3Z8A22G0P002	30553120	8.25" x 82'	HS Black	Fan Fold	312 sheets	80mm perf/fold	THB 307
Trendcom								
100	MMM 78-6145-9005-3	10794536	4.438" x 80'	HS Black	Out	N/A	0.450"	MMM 304
Varian								
Vista 401	VN 03-906265-00 BL	10245844	8.5" x 184'	HS Blue	Fan Fold	200 sheets	11" perf/fold	VN 309
	VN 03-906265-00 BK	10066240	8.5" x 184'	HS Black				VN 308
3400	PNR NO 202	01005958	4.33" x 150'	HS Black	Out	N/A	0.472"	PNR 202
4270, 4290	VN 00-997096-01	01249119	9.344" x 167'	HS Black	Fan Fold	180 sheets	11" perf/fold	VN 310
Veeder-Root								
576008-424	FLU Y2035	10373604	62mm x 235'	HS Black	Out	N/A	0.450"	FLU 002
VME Associates								
Plain Roll	PPR VME 250-0001	30912078	49mm x 65'	PS Black Wax	In	N/A	0.625"	PPR 123
Multi-Purpose dataGRAPHIC® Products								
Fan Fold	PNP NO 008	30796117	3" x 115'	Inkwriting 4.1mil	Fan Fold	250 sheets	5.5" perf/fold	PNP 008
	PNP NO 009	30799640	3.5" x 66'	Inkwriting 1.9mil		268 sheets	75mm perf/fold	PNP 009
	PNP NO 010	30920311	9.5" x 425'	HS Black		600 sheets	8.5" perf/fold	PNP 097
	PNP NO 012	30972577	11.75" x 500'	HS Black		500 sheets	12" perf/fold	PNP 012
	PNP NO 154	10304948	8" x 496'	Inkwriting 1.9mil		700 sheets	8.5" perf/fold	PNP 154

ES = Electrosensitive
HS = Heat Sensitive

Instrument/Model No.(s) To Fit:	Graphic Controls Equivalent	Reorder/ Part Number	Size W x L	Media Type/ Trace	Wound	Roll Diameter	Core ID	Price Code	
Multi-Purpose dataGRAPHIC® Products (Continued) Roll	PNP NO 102	00391615	9" x 80'	Inkwriting 2.2mil	Out	5.5"	1.125"	PNP 102	
	PNP NO 151	10188481	2.25" x 70'	Inkwriting 4.1mil		N/A	0.453"	PNP 151	
	PNP NO 157	10687870	2.25" x 80'	HS Blue		1.938"	0.470"	PNP 157	
	PNP NO 158	10687821	2.25" x 80'	HS Black		1.938"	0.470"	PNP 158	
	PNP NO 160	10085240	25" x 200'	ES Black	In	N/A	1.500"	PNP 160	
	PNP NO 162	10160415	2.5" x 250'	Red Wax		N/A	0.500"	PNP 162	
	PNP NO 181	10581016	12.5" x 150'	Inkwriting 2.6mil	Out	N/A	0.562"	PNP 181	
	PNR NO 188 (7999100)	30706132	2.25" x 90'	ES Metallized		N/A	0.640"	PNR 188	
	PNR NO 188 PLASTIC CORE	30976750	2.25" x 90'	ES Metallized		N/A	1.000"	PNR 188	
	PNR NO 188 1/2" ID PLASTIC CORE	31068557	2.25" x 90'	ES Metallized		N/A	0.500"	PNR 188	
	PNR NO 198 9-1/2" x 100' 114 PAPR	10894971	9.5" x 100'	Vellum H 3.5mil		Punched Roll	0.750"	PNR 198	
	PNR NO 198 9-1/2" x 200' 114 PAPR	31010716	9.5" x 200'	Vellum H 3.5mil		Punched Roll	0.750"	PNR 198	
	PNR NO 201	01003151	60mm x 98'	ES Metallized		N/A	0.472"	PNR 201	
	PNR NO 202	01005958	4.33" x 150'	HS Black		N/A	0.472"	PNR 202	
	PNR NO 205	01042423	12.188" x 200'	ES Black		In	N/A	1.500"	PNR 205
	PNR NO 206	01042415	18.063" x 200'	ES Black			N/A	1.500"	PNR 206
	PNR NO 217	01100049	2.5" x 150'	HS Blue	Out	2.60"	0.406"	PNR 217	
	PNR NO 222	01249184	104mm x 70'	HS Black		1.75"	0.472"	PNR 222	
	PNR NO 224	20000644	14.875" x 200'	Inkwriting 2.6mil		N/A	1.031"	PNR 224	
	PNR NO 231	30535556	4.313" x 42.5'	HS Black		1.50"	0.472"	PNR 231	
	PNR NO 234	30557147	2.813" x 85'	HS Black		2.0"	0.472"	PNR 234	
	PNR NO 240	30582319	2.813" x 150'	HS Black		2.0"	0.472"	PNR 240	
	PNR NO 242	30589728	71mm x 85'	HS Black 616		2.0"	0.472"	PNR 242	
	PNR NO 245	30601291	72mm x 80'	HS Black 936		1.875"	0.472"	PNR 245	
	PNR NO 246	30601317	4.344" x 96'	HS Black 929		N/A	0.500"	PNR 246	
	PNR NO 248	30635034	3.375" x 150'	Inkwriting 4mil 1		N/A	0.468"	PNR 248	
	PNR NO 249	30638434	2.25" x 48'	HS Black 616		1.469"	0.453"	PNR 249	
PNR NO 250	30639804	127.5mm x 78'	HS Black 603	1.80"		0.472"	PNR 250		
PNR NO 251	30641446	4.5" x 82'	Inkwriting 2.6mil 82	In		2.0"	0.469"	PNR 251	
PNR NO 259	30664901	60mm x 96'	HS Black 616	Out		N/A	0.437"	PNR 259	
PNR NO 261	30679800	2.25" x 52'	HS Black 616		N/A	0.334"	PNR 261		
PNR NO 265	30717980	4.44" x 132'	HS Black 616	In	N/A	0.250"	PNR 265		
PNR NO 267	30738036	4.375" x 59'	HS Black 603	Out	1.575"	0.279"	PNR 267		
PNR NO 268	30738077	4.688" x 65'	HS Black 616		N/A	0.437"	PNR 268		
PNR NO 269	30776853	58mm x 130'	HS Black 616	Out	2.438"	0.438"	PNR 269		
PNR NO 270	30789062	2.25" x 48'	HS Black 631	In	1.469"	0.453"	PNR 270		
PNR NO 271	30803285	58mm x 140'	HS Black 631		2.438"	0.438"	PNR 271		

ES = Electrosensitive
HS = Heat Sensitive

Instrument/Model No.(s) To Fit:	Graphic Controls Equivalent	Reorder/ Part Number	Size W x L	Media Type/ Trace	Wound	Roll Diameter	Core ID	Price Code
Multi-Purpose dataGRAPHIC® Products (Continued) Roll (Continued)	PNR NO 272	30803327	4.469" x 150'	HS Black 616	Out	2.438"	0.480"	PNR 272
	PNR NO 273	30809589	8.469" x 150'	HS Black 616		3.0"	1.000"	PNR 273
	PNR NO 275	30916350	70mm x 98'	ES Metallized 171		N/A	0.453"	PNR 275
	PNR NO 277	30934346	110mm x 7M	HS Black 304		1.188"	coreless	PNR 277
	PNR NO 278	30939980	8.25" x 164'	HS Black 616		N/A	0.468"	PNR 278
	PNR NO 279	30940368	5.25" x 300'	Inkwriting 2.2mil 5		N/A	0.750"	PNR 279
	PNR NO 280	30946449	2.438" x 150'	HS Black 616	In	2.50"	0.390"	PNR 280
	PNR NO 281	30969409	6.688" x 150'	HS Black 616	Out	4.0"	1.250"	PNR 281
	PNR NO 282	30990389	2.25" x 130'	ES Metallized 171		N/A	1.000"	PNR 282
	PPR ORN 0900A4	30909249	1.5" x 26'	HS Black 304		0.500"	PPR 082	
	PPR PPR1570B	30919255	4.406" x 80'	HS Black 936		0.437"	PPR 088	
	PPR PPR1690B	30910601	2.25" x 150'	HS Black 936		0.625"	PPR 104	
	PPR PPR1950B	30912268	60mm x 65'	ES Metallized 171		0.437"	PPR 140	
	PPR PPR2900B	30926839	2.25" x 150'	HS Black 936		0.625"	PPR 105	
	PPR PPR3110B	30911195	4.313" x 100'	HS Black 920		0.515"	PPR 160	
	PPR PPR3240A	30911484	110mm x 115'	HS Blue 44		0.470"	PPR 159	
	PPR PPR3270A NO ERW	30910668	2.25" x 150'	HS Blue 44		0.625"	PPR 189	
	PPR PPR3270B NO ERW	30910577	2.25" x 150'	HS Black 920	0.625"	PPR 217		
	PPR PPR3770B	30912086	50mm x 85'	HS Black 304	In	N/A	0.625"	PPR 164
	PPR PPR7680B	30919545	6.25mm x 900'	HS Black 304	Out	6.0"	0.500"	PPR 285
Sheet	PNS NO 27	00391961	12" x 12"	Blotter Stock 10	Sheet	-	100 shts/pk	PNS 012
	PNS NO 50	00698852	12" x 14"	Blotter Stock 10				PNS 050
	PNS NO 63	10807551	11.75" x 36"	HS Black 945				PNS 063
	PNS NO 64	30786449	340mm x 610mm	HS Black 945			100 shts/pk, 15 packs/bx	PNS 064
	PNS NO 68	01097997	2.563" x 5.688"	Red Wax 18			100 shts/pk	PNS 068

ES = Electrosensitive
HS = Heat Sensitive

The papers we recommend are carefully selected and have undergone extensive laboratory performance analysis prior to their introduction. We warrant our products are free from defects in material and workmanship and will offer full replacement or credit for products which we supply that are defective and returned by the customer.

We also warrant that our products will not cause excessive or abnormal wear to your instrument print head. However, under the following conditions, we will bear the cost of service and repair of machines if damaged, excluding normal wear and tear, by use of our paper:

1. Signed documentation from a service representative stating abnormal wear can be established as a direct result of exclusive and continuous use of Graphic Controls products.
2. Reasonable precautions have been taken in the handling, storage, and use of Graphic Controls products.
3. Report of such damage is reasonable and prompt.
4. Damaged print head should be forwarded directly to Graphic Controls, Attn: QA/QC Dept.

dataGRAPHIC®
Product Warranty
.....

Engineering Pads

.....
Industrial Monitoring Solutions

Graphic Controls offers engineering pads in several configurations. Standard pads are printed with non-reproducible blue ink. Choose from the three different, high quality paper stocks available.

For variety and dependability, you can rely on engineering pads from Graphic Controls.

How to Order Engineering Pads

Engineering pads ordering information is listed by paper type: Velar 450, Reprovel® 4440M and Bondtex® 150.

When ordering, it is important to indicate whether or not 3-ring punching and/or standard heading is desired. Please add one of the following suffixes to the part number:

SH-P Standard Heading* - Punched

SH-NP Standard Heading* - No Punch

NH-P No Heading - Punched

NH-NP No Heading - No Punch

Example: 11-450-01-SH-P

11-450-01-NH-NP

Please note that Standard Packaging** is available as follows:

Size	Sheets per Pad	Pads per Pack
8-1/2" x 11"	50	10
11" x 17"	50	5
12" x 18"	50	5

** Place orders in minimums and multiples of five pads.

* Standard Heading Format

BY _____ DATE _____ SUBJECT _____ SHEET NO. _____ OF _____

CHKD. BY _____ DATE _____ JOB NO. _____

Product and company names listed are trademarks or trade names of their respective companies.

Paper Styles

Velar 450

A transparentized 100% rag vellum, Velar 450 will not become brittle with age. It is highly transparent and will give excellent reproductions - it may be used for blueprint, black and white, or diazo reproductions. The grids will not reproduce. For best results, use a fast speed reproduction paper.

Reprovel® 440M

This transparentized 100% rag vellum, has enhanced strength, moisture resistance, stability, erasability, and reproduction qualities. Reprovel® 440M may be used for blueprint, black and white, or diazo reproductions. The grid will not reproduce. For best results, use a fast speed reproduction paper.

Bondtex® 150

When a paper that will withstand considerable handling is required, depend on Bondtex® 150. This is a high quality rag natural tracing paper with excellent erasing and reproduction qualities. It may be used for blueprint, black and white, or diazo reproductions - the grid will not reproduce. For best results, use a fast speed reproduction paper.

Special Orders

Upon request, unpadding material, reproducible blue, blank sheets and bleed off grids are available.

Custom headings may also be ordered. Mail us a sample of your requirements. A special part number will be assigned. Please request quotations for these items.

Paper Type/ Grid Type	Grid Configurations		Part Numbers		
	Divisions	Lines Accented	8-1/2" x 11" Pads*	11" x 17" Pads	12" x 18" Pads
Velar 450					
Isometric- Orthographic	4 x 4 to the inch	4th Line accented	11-450-01	17-450-01	-
	8 x 8 to the inch	8th Line accented			
Isometric- Orthographic	5 x 5 to the inch	2nd Line accented	11-450-02	-	-
	5 x 5 to the inch	All Lineweights equal			
Isometric	4 x 4 to the inch	4th Line accented	11-450-03	17-450-03	-
Square	4 x 4 to the inch	All Lineweights equal	11-450-04	17-450-04	-
Square	5 x 5 to the inch	All Lineweights equal	-	17-450-05	18-450-05
Square	6 x 6 to the inch	All Lineweights equal	-	-	18-450-06
Square	8 x 8 to the inch	8th Line accented	11-450-08	17-450-08	18-450-08
Square	10 x 10 to the inch	10th Line accented	11-450-10	17-450-10	18-450-10
Square	10 x 10 to the cm	5th Line accented, 10th Line heavy	11-450-11	17-450-11	-
Square	12 x 12 to the inch	12th Line accented	-	-	18-450-12
Reprovel® 440M					
Isometric- Orthographic	4 x 4 to the inch	4th Line accented	11-440-01	17-440-01	18-440-01
	8 x 8 to the inch	8th Line accented			
Isometric- Orthographic	5 x 5 to the inch	2nd Line accented	11-440-02	17-440-02	-
	5 x 5 to the inch	All Lineweights equal			
Isometric	4 x 4 to the inch	4th Line accented	11-440-03	17-440-03	-
Isometric	10 x 10 to the inch	5th Line accented	11-440-13	17-440-13	-
Square	4 x 4 to the inch	All Lineweights equal	-	17-440-04	-
Square	5 x 5 to the inch	All Lineweights equal	11-440-05	-	-
Square	8 x 8 to the inch	8th Line accented	11-440-08	17-440-08	-
Square	10 x 10 to the inch	10th Line accented	11-440-10	-	18-440-10
Bondtex® 150					
Isometric- Orthographic	4 x 4 to the inch	4th line accented	11-150-01	17-150-01	18-150-01
	8 x 8 to the inch	8th Line accented			
Isometric- Orthographic	5 x 5 to the inch	2nd Line accented	11-150-02	17-150-02	-
	5x5 to the inch	All Lineweights equal			
Isometric	4 x 4 to the inch	4th Line accented	11-150-03	17-150-03	-
Square	4 x 4 to the inch	All Lineweights equal	11-150-04	17-150-04	-
Square	5 x 5 to the inch	All Lineweights equal	11-150-05	-	-
Square	6 x 6 to the inch	All Lineweights equal	-	17-150-06	-
Square	8 x 8 to the inch	8th Line accented	11-150-08	17-150-08	-
Square	10 x 10 to the inch	10th Line accented	11-150-10	17-150-10	-
Square	10 x 10 to the cm	5th Line accented, 10th Line heavy	11-150-11	17-150-11	-
Square	12 x 12 to the inch	12th Line accented	11-150-12	-	-
Square	20 x 20 to the inch	10th Line accented, 20th Line heavy	11-150-20	17-150-20	-

* 8-1/2" x 11" pads are punched for standard 3 ring binders.

For Standard Heading Format, see pg. 110.

Graph Paper

Now you can have graph paper printed with the same accuracy as Graphic Controls Recording Charts. Choose from the items listed here, or call us. If you have special requirements, even unique sizes and shapes, we will work with you to provide these specialized items.

.....
Industrial Monitoring Solutions

Types of Grid Configurations

Square Grids are used generally to show changes in quantities and amounts.

Rectangular Grids provide the most natural intervals for moving line graphs.

Logarithmic (Full Log) Grids are used to plot relationships that involve multiplication, division, raising to powers, or extracting square roots.

Semi-Log Grids show the ratio of one set of figures to another.

Triangular Grids are used for plotting curves.

Circular Grids are available in four general styles. For trigonometry/calculus; for polar coordinates; a special polar grid for lighting studies; and a "pie chart" circle divided into 100 points for percentages or parts of a whole.

Probability Grids are used for converting a bell-shaped curve into a straight line.

Material

Graphic Controls Graph Paper is available in three high quality paper stocks: Drawing, Tracing and Vellum. Your choice of stock should be determined by the purposes to be fulfilled by your graph.

Drawing Paper is a heavy, durable stock which withstands day-to-day handling.

Tracing Paper can be used for both reproduction and overlay comparisons.

Vellum is hardiest of the stocks being a rag bond specially treated for transparency and strength. Grids are printed on the reverse side of the stock to permit frequent erasures without weakening or destroying the grid line printing.

Sizes and Shapes

Graphic Controls Graph Paper comes in two standard sizes: 8-1/2" x 11" and 11" x 16-1/2" in boxes of 100 sheets (padding is available on request). Special sizes can also be supplied in most any size you need. Five-ring punching is standard.

Graphic Controls graph configurations are also available in roll form. Please inquire.

The Graphic Controls graph paper part number is made up of a combination of alpha and numeric characters. To assist you in identifying the desired item, the system is explained below:

Part Number:	A	S	-	0	8	0	1	-	G	D	R
	⋮	⋮		⋮	⋮	⋮	⋮		⋮	⋮	⋮
Position:	1	2		3	4	5	6	7	8	9	10

Position 1 - Always alpha, used to designate sheet size:

A = 8-1/2 x 11	E = 8-1/2 x 14	K = 11-1/2 x 17	O = 10-3/4 x 13-1/4
B = 11 x 16-1/2	F = 8-3/4 x 14	L = 11-1/2 x 11-1/2	P = 13 x 19
C = 12 x 18	G = 7 x 8-1/2	M = 10-1/2 x 15	Q = 8-1/2 x 22
D = 11 x 17	H = 8-1/2 x 12-1/4	N = 16 x 21	S = 8 x 10-1/2

In the example, A = 8-1/2 x 11

Position 2 - Always alpha, used to designate grid type:

C = Circular	H = Hyperbolic (Reciprocal)	P = Probability	
D = Semi-log	L = Log-log	R or T = Rectangular	Z = Perspective
G = Gaussian Scale	N = Blank	S = Square	

In the example, S = Square

Positions 3 and 4 - Always numeric, used to designate grid size:

In the example, 08 = 7 x 10

Positions 5, 6 and 7 - Always numeric, may consist of two or three digits, used to identify grid configurations:

Two numbers are used in the example and identify the configuration as: 4 x 4 divisions to the inch with each fourth line accented.

Position 8 - Identifies color:

A = Brown	G = Green (reproducible)	O = Orange	R = Red
B = Blue	N = No color	P = Purple	

In example, G = Green

Position 9 - Used to identify paper type:

D = Drawing	T = Tracing
V = Vellum	

In the example, D = Drawing

Position 10 - Letter R is used to indicate a Graph Roll

To order simply find the paper size and grid configuration you require in the Graph Paper Listing which follows.

For Example, an 8 1/2 x 11 sheet, 10 x 10 grid, 10th line accented would be: AS-0806-

Add the alpha characters designating the color and paper type you require to the end of the part number.

For example, AS-0806-GD: indicates grid printed in Green (G) on Drawing Paper (D)

Product and company names listed are trademarks or trade names of their respective companies.

**How to Order
Graph Paper**

.....

Square [Cross Section] Grids

Sheet Size (Inches)	Divisions (To the Inch)	Accented Lines	Grid Size (Inches)	Part Number
8-1/2 x 11	4 x 4	4	7 x 10	AS-0801-
8-1/2 x 11	4 x 4	All Equal	7 x 10	AS-08166-
8-1/2 x 11	5 x 5	5	7 x 10	AS-0802-
8-1/2 x 11	5 x 5	All Equal	7 x 10	AS-08167-
8-1/2 x 11	6 x 6	6	7 x 10	AS-0803-
8-1/2 x 11	8 x 8	8	7 x 10	AS-0804-
8-1/2 x 11	8 x 8	4, 8	7 x 10	AS-0860-
8-1/2 x 11	8 x 8	5	7 x 10	AS-08107-
8-1/2 x 11	10 x 10	All Equal	7 x 10	AS-0805-
8-1/2 x 11	10 x 10	10	7 x 10	AS-0806-
8-1/2 x 11	10 x 10	5, 10	7 x 10	AS-0807-
8-1/2 x 11	12 x 12	3, 6, 12	7 x 10	AS-0808
8-1/2 x 11	12 x 12	12	7 x 10	AS-0861-
8-1/2 x 11	12 x 12	5, 10	7-1/2 x 10	AS-1164-
8-1/2 x 11	16 x 16	16	7 x 10	AS-0809-
8-1/2 x 11	16 x 16	8th Accented 16th Heavy	7 x 10	AS-08169-
8-1/2 x 11	20 x 20	5, 10, 20	5 x 7-1/2	AS-5810-
8-1/2 x 11	20 x 20	10	7 x 10	AS-0863-
8-1/2 x 11	20 x 20	All Equal 10th Accented	7 x 10	AS-08108-
8-1/2 x 11	20 x 20	20th Heavy	7 x 10	AS-08170-
8-1/2 x 11	20 x 20	5, 10, 20	7-1/2 x 10	AS-1110-
8-1/2 x 11	20 x 20	10	7-1/2 x 10	AS-1163-
11 x 16-1/2	5 x 5	5	10 x 15	BS-2002-
11 x 16-1/2	8 x 8	8	10 x 15	BS-2004-
11 x 16-1/2	10 x 10	10	10 x 15	BS-2006-
11 x 16-1/2	10 x 10	5, 10	10 x 15	BS-2007-
11 x 16-1/2	12 x 12	3, 6, 12	10 x 15	BS-2008-
11 x 16-1/2	12 x 12	5	10 x 15	BS-2064-
11 x 16-1/2	20 x 20	5, 10, 20 5th, 10th Accented,	10 x 15	BS-2010-
11 x 16-1/2	20 x 20	20th Heavy 3-3 x 15" Grids with 1/2" Space Between Each Channel	10 x 15	BS-20163-
11 x 17	12 x 12	12 4th, 8th Accented	11 x 17	DS-71178-
18 x 23	16 x 16	16th Heavy	16 x 21	US-68176-
(To the 1/2 inch)				
8-1/2 x 11	5 x 5	5	7 x 10	AS-0811-
8-1/2 x 11	10 x 10	5, 10	6 x 9	AS-2113-
8-1/2 x 11	10 x 10	5, 10	7 x 10	AS-0813-
8-1/2 x 11	10 x 10	5, 10	7-1/2 x 10	AS-1113-
11 x 16-1/2	8 x 8	4, 8	10 x 15	BS-2012-
11 x 16-1/2	10 x 10	5, 10	10 x 15	BS-2013-
(To the cm)				
8-1/2 x 11	5 x 5	5	18 x 24	AS-8584-
8-1/2 x 11	10 x 10	5, 10	16 x 22	AS-8314-
8-1/2 x 11	10 x 10	5, 10	18 x 25	AS-8014-
8-1/2 x 11	10 x 10	10th Heavy 5th, 10th	18 x 25	AS-80165-

Square [Cross Section] Grids [Continued]

Sheet Size (Inches)	Divisions (To the cm)	Accented Lines	Grid Size (Inches)	Part Number
8-1/2 x 11	10 x 10	Accented, 50th Heavy	18 x 25	AS-80177-
8-1/2 x 11	10 x 10	5, 10	20 x 25	AS-8414-
11 x 16-1/2	10 x 10	5, 10	25 x 38	BS-8114-
18 x 23	10 x 10	5, 10	40 x 50	US-8914-

Rectangular Grids

Sheet Size (Inches)	Divisions		Accented Lines		Grid Size (Inches)	Part Number
			Short Side	Long Side		
8-1/2 x 22	150 x 200		5th Accented, 10th Heavy	4th Heavy	7-1/2 x 19 29/32	QR-63160-
Long Range Trends						
8-1/2 x 11	12 x 20 to 1 in.		10, 20	6, 12	7 x 10	AR-0818-
11 x 16-1/2	12 x 20 to 1 in.		10, 20	6, 12	10 x 15	BR-2018-
Time Series	Short Side	Long Side				
1 Day by Hours:						
8-1/2 x 11	100	48	5, 10	Hours Numbered	6 x 9	AR-21111-
8-1/2 x 11	100	48	5, 10	Hours Numbered	7 x 9-5/8	AR-41110-
1 Month by Days:						
8-1/2 x 11	31	110	Numbered Equal	5, 10, 5th No'd.	6 x 9 1/8	AR-0320-
8-1/2 x 11	10	31	Numbered Equal	Equal	7 x 9-1/2	AR-29147-
6 Months by Days:						
8-1/2 x 11	120	186	10	Mo. Bxs., 5th day No'd.	7 x 10	AR-0886-
11 x 16-1/2	90	182	5, 10	Jan. - Jun. Printed, 5th day No'd.	9 x 13-5/8	BR-2665-
1 Year by Days:						
8-1/2 x 11	250	366	5, 10	Mos. Printed, 5th day No'd.	6-1/4 x 9	AR-3723-
11 x 16-1/2	150	366	5, 10	Mos. Printed, 5th day No'd.	7-1/2 x 14-5/8	BR-1322-
11 x 16-1/2	180	372	5, 10	Mo. Lines, 5th day No'd.	9 x 14	BR-1521-
11 x 16-1/2	250	366	5, 10	Mos. Printed, 5th day No'd.	9-3/4 x 14-5/8	BR-1623-
1 Year by Weeks:						
8-1/2 x 11	52	180	13	5, 10	6-1/2 x 9	AR-0524-
11 x 16-1/2	100	52	5, 10	1-52	9 x 14	BR-15175-
1 Year by Months:						
8-1/2 x 11	13	150	Mos. Printed	5, 10, 10th No'd.	6-1/2 x 8	AR-0425-
5 Years by Months:						
8-1/2 x 11	100	60	5, 10, 10th No'd.	Mos. Printed, Yr. Bxs.	6-1/2 x 10	AR-0626-
11 x 16- 1/2	100	60	5, 10, 10th No'd.	Mos. Printed, Yr. Bxs.	9-1/2 x 14	BR-4026-
10 Years by Months:						
11 x 16-1/2	110	120	5, 10, 10th No'd.	Mos. Printed, Yr. Bxs.	9-3/4 x 14	BR-2769-
Iso-Ortho:						
8-1/2 x 11	60°	2 x 2 to cm	Equal	Equal	7 x 10	AR-0827-
Isometric:						
8-1/2 x 11	60°	4 x 4 to in.	4	4	7 x 10	AR-0828-
8-1/2 x 11	60°	8 x 8 to in.	4	8	7 x 10	AR-0897-
11 x 16-1/2	60°	4 x 4 to in.	4	8	10 x 15	BR-2097-
11 x 16-1/2	60°	8 x 8 to in.	4	8		
11 x 16-1/2	60°	4 x 4 to in.	4	8		

Rectangular Grids (Continued)

Sheet Size (Inches)	Divisions		Accented Lines		Grid Size (Inches)	Part Number
	Short Side	Long Side	Short Side	Long Side		
Security Prices - 53 weeks of 5 days:						
11 x 16-1/2	200	265	2, 8	5	10 x 15	BR-2094-
Commodity Prices - 53 weeks of 6 days:						
11 x 16-1/2	200	318	10	6	10 x 15	BR-20120-

Semi-Log Grids

Sheet Size (Inches)	No. of Log Cycles (Inches)	Length of Each Cycle (Inches)	Divisions Uniform Scale	Accented Lines	Grid Size		Part Number
					Log Size (Inches)	Uniform Size (Inches)	
8-1/2 x 11	1	10	60	6	10	7	AD-0829-
8-1/2 x 11	1	10	70	5, 10	10	7	AD-0830-
8-1/2 x 11	1	10	84	6	10	7	AD-08112-
8-1/2 x 11	2	3-3/4	200	5	7-1/2	10	AD-1171-
8-1/2 x 11	2	5	60	6	10	7	AD-0832-
8-1/2 x 11	2	5	70	5, 10	10	7	AD-0833-
8-1/2 x 11	2	5	70	5, 10	10	7 1/2	AD-5130-
8-1/2 x 11	2	5	84	6	10	7	AD-0835-
8-1/2 x 11	2	5	140	5, 10	10	7	AD-0836-
8-1/2 x 11	3	2	200	5, 10	6	9	AD-21172-
8-1/2 x 11	3	2.5	200	5, 10	7-1/2	10	AD-11179-
8-1/2 x 11	3	3-1/3	60	6	10	7	AD-0888-
8-1/2 x 11	3	3-1/3	70	5, 10	10	7	AD-0837-
8-1/2 x 11	3	3-1/3	84	6	10	7	AD-0868-
8-1/2 x 11	3	3-1/3	140	5, 10	10	7	AD-0840-
8-1/2 x 11	4	2-1/4	70	6	9	7	AD-2873-
8-1/2 x 11	4	2-1/2	60	6	10	7	AD-0842-
8-1/2 x 11	4	2-1/2	70	5, 10	10	7	AD-0843-
8-1/2 x 11	5	1.8	72	6	9	6	AD-21118-
8-1/2 x 11	5	2	70	5, 10	10	7	AD-0845-
8-1/2 x 11	6	1-1/2	120	-	9	6	AD-21192-
8-1/2 x 11	7	1-1/4	60	5	8-3/4	6	AD-2346-
11 x 16-1/2	1	10	150	5, 10	10	15	BD-20106-
11 x 16-1/2	1	10	180	6	10	15	BD-2031-
11 x 16-1/2	2	5	150	5, 10	10	15	BD-2034-
11 x 16-1/2	3	3-1/3	150	5, 10	10	15	BD-2038-
11 x 16-1/2	3	3-1/3	180	6	10	15	BD-2039-
11 x 16-1/2	3	3-1/3	300	5, 10	10	15	BD-2041-
11 x 16-1/2	4	2-1/2	150	5, 10	10	15	BD-2044-
11 x 16-1/2	5	3	200	5, 10	15	10	BD-2076-
11 x 16-1/2	7	2	100	-	14	10	BD-32164-
Security Price Trend 1 Year by Days x Log:							
11 x 16-1/2	3	3	366	Mo. Lines 5th Day No'd.	9	14	BD-15123-

Full Log Grids

Sheet Size (Inches)	Number of Log Cycles (Units)	Length of Each Cycle (Inches)	Grid Size (Inches)	Part Number
8-1/2 x 11	1 x 1	7-1/2 x 7-1/2	7-1/2 x 7-1/2	AL-0947-
8-1/2 x 11	2 x 1	5 x 5	5 x 10	AL-0148-
8-1/2 x 11	2 x 2	3-3/4 x 3-3/4	7-1/2 x 7-1/2	AL-0949-
8-1/2 x 11	2 x 2.7	3-3/4 x 3-3/4	7-1/2 x 10-3/8	AL-1292-
8-1/2 x 11	2 x 3	3-1/3 x 3-1/3	6-2/3 x 10	AL-2451-
8-1/2 x 11	3 x 5	1.85 x 1.85	5-9/16 x 9-1/4	AL-0254-
8-1/2 x 11	3 x 5	2 x 2	6 x 10	AL-62155-
11 x 16-1/2	1 x 1	7-1/2 x 7-1/2	9.85 x 9.85	BL-1747-
11 x 16-1/2	1 x 1	9.85 x 9.85	9.85 x 9.85	BL-17180-
11 x 16-1/2	2 x 2	5 x 5	10 x 10	BL-1850-
11 x 16-1/2	2 x 3	5 x 5	10 x 15	BL-2052-
11 x 16-1/2	3 x 5	3 x 3	9 x 15	BL-1455-

Time-Current Characteristics: Short Side - Current in Amperes - .5 to 10,000

Long Side - Time in Seconds - .01 to 1,000

10 1/2 x 15	4 1/2 x 5	2-1/8 x 2-1/8	9-1/2 x 11-1/16	ML-59149-
-------------	-----------	---------------	-----------------	-----------

Weapons Effect:

8 1/2 x 11	5 x 3	1.85 x 1.85	5-9/16 x 9-1/4	AL-02127-
------------	-------	-------------	----------------	-----------

Special Grids

Sheet Size (Inches)	Graph Description	Grid Size (Inches)	Part Number
8-1/2 x 11	Circular percentage: to show percentage by sectors. One 6 inch circle, div. to 1/2 %; two 2 inch circles, div. to 1%	–	AC-03131-
8-1/2 x 11	Focus-Directrix Conic Paper.	–	AC-72181
8-1/2 x 11	Focus-Focus Conic Paper.	–	AC-73182-
8-1/2 x 11	Audio-Frequency: Semi-log grid long side; 20-20,000 cycles a second: 10 x 10 to 1/2 inch short side; 5th and 10th lines accented.	6 x 9	AD-2190-
8-1/2 x 11	Reactance-Frequency: For analyzing the relationships between electrical variables such as reactance, capacitance, inductance and frequency.	5-3/4 x 8	AL-31135-

Sheet Size (Inches)	Uniform Divisions Short Side	Grid Long Side	Accented Lines	Grid Size (Inches)	Part Number
---------------------	------------------------------	----------------	----------------	--------------------	-------------

Reciprocal Absolute Temperature 300°C to 40°C

8-1/2 x 11	Reciprocal Rule	4 Log Cycles	–	7 x 8	AH-48137-
------------	-----------------	--------------	---	-------	-----------

Sheet Size (Inches)	Divisions (To the cm)	Accented Lines	Grid Size (Inches)	Part Number
---------------------	-----------------------	----------------	--------------------	-------------

Circular Polar Co-ordinate

8-1/2 x 11	10 Parts to Inch	–	7 x 10	AC-0815-
8-1/2 x 11	10 Parts to Inch	–	7-1/2 x 10	AC-11115-

Triangular Co-ordinate

8-1/2 x 11	100 Parts Each	No'd. Ea. 5 Divisions	23 x 23 x 23 cm	AT-8216-
------------	----------------	-----------------------	-----------------	----------

Probability By:

8-1/2 x 11	90 Divisions	5, 10	6-5/8 x 9-1/4	AP-0756-
8-1/2 x 11	100 Divisions	–	7 x 9-1/2	AP-29159-
8-1/2 x 11	2 Log Cycles Short Side	–	7-1/2 x 9-1/4	AP-1057-
8-1/2 x 11	3 Log Cycles with Probability	–	6-1/2 x 9	AP-0593-

This section contains cross reference information to help you easily locate the correct equivalent Graphic Controls part number if you are presently using any of the following graph paper numbers:

- Bruning • B. K. Elliott
- Clearprint • Graphic Controls Canada Ltd.
- Codex • Kueffel & Esser Co.
- Dietzgen • Lietz

Bruning Instruments

Cross Reference To

Graphic Controls

Bruning No.	GC No.
40-810	RS-6406-OTR
40-8403	AS-0810-OT
40-8407	BS-2010-OT
40-8410	AS-0810-GD
40-8417	RS-2010-GD
40-8490	AS-0808-OT
40-8500	AS-0806-OT
40-8511	AS-0806-GD
40-8530	AS-0804-OT
40-8550	AS-0804-GD
40-8591	AS-0801-OT
40-8701	AS-8014-OT
40-8721	AS-8014-GD
40-8751	AL-0947-OT
40-8753	AL-0949-OT

Clearprint Instruments

Cross Reference To

Graphic Controls

Clearprint No.	GC No.
C-35	AS-0807-AV
C-38	AS-1113-AV
C-38X	AS-1110-AV
C-39	AS-8314-AV
C-39X	AS-8414-AV
C-45	BS-2007-AV
C-48	BS-2010-AV
C-49	BS-8114-AV
C-304	AS-0858-AV
C-305	AS-0802-AV
C-306	AS-0859-AV
C-308	AS-0860-AV
C-310	AS-2113-AV
C-315	AD-0840-AV
C-317	AR-3723-AV

Clearprint Instruments (Continued)

Clearprint No.	GC No.
C-322	AR-4881-AV
C-323	AL-1292-AV
C-324	AC-1115-AV
C-325	AR-1127-AV
C-327	AP-0756-AV
C-328	AP-1057-AV
C-366	AR-2199-AV
C-410	BS-2013-AV
C-417	BR-1322-AV
C-423	BL-1455-AV
C-456	BR-2769-AV
C-496	BR-2665-AV
C-497	BR-2566-AV
C-3120	AR-0626-AV
C-3190	AS-0806-AV
C-3290	AL-0947-AV
C-3291	AL-0949-AV
C-3291A	AL-0949-AV
C-4120	BR-4026-AV
C-4190	BS-2006-AV

Codex Instruments

Cross Reference To

Graphic Controls

Codex No.	GC No.
311	AS-0801-OT
312	AS-0802-GT
313	AS-0803-OT
314	AS-0804-OT
315	AS-0807-GT
316	AS-0808-GT
317	AS-0812-GT
318	AS-1113-GT
318 A	AS-1110-GT
319	AS-8314-GT
319 A	AS-8414-GT
319C	AS-0814-GT

Codex Instruments (Continued)

Codex No.	GC No.
325	AS-0807-GD
326	AS-0808-GD
328	AS-1113-GD
328A	AS-1110-GD
328 B	AS-1113-BD
329	AS-8314-GD
329 A	AS-8414-GD
329 B	AS-8014-BD
340-16	AS-0809-GT
340-20L	AS-1110-GT
340-20P	AS-0810-GT
340-L35	AL-0254-GT
340-L412	AD-2873-GT
340-T6	AR-0320-GT
340-T33	AR-0626-GT
340-TC	AT-8216-GT
340A-8	AS-0860-GV
340A-10	AS-0806-GV
340A-20	AS-1110-GV
340D-37	BR-20121-GT
340D-L112	BD-2031-GT
340D-T12	BR-1623-GT
340DR-T12	BR-1623-OT
340R-16	AS-0809-OT
340R-20L	AS-1110-OT
340R-L35	AL-0254-OT
340R-P	AC-0815-OT
340R-T6	AR-0320-OT
341-16	AS-0809-GD
341-20L	AS-1110-OD
341-P	AC-0815-GD
341-T6	AR-0320-GD
341B-10-1/2	AS-0813-BT
415	BS-2007-GT
418	BS-2010-GT
419	BS-8114-GT
419 R	BS-8114-OT
425	BS-2006-GD
429	BS-8114-GD
429 B	BS-8114-BD
3110	AS-0810-GD
3110 R	AS-0810-OT
3115	AD-0840-AV
3117	AR-3723-OT
3118	AD-1171-GT
3122	AR-4881-OT
3124	AC-1115-GT
3126	AT-8216-OT
3127	AP-0756-GT
3128	AP-1057-GT
3133	AM-31186-GT
3166	AR-2199-OT

Codex Instruments (Continued)

Codex No.	GC No.
3174	AD-2873-GT
3176	AR-21111-GD
3187	AS-0805-GT
3226	AT-8216-GD
3228	AP-1057-GD
3250	AR-21199-GD
3257	AD-05190-GD
4110	BS-2013-GT
4110 R	BS-2010-OT
4113	BD-2072-GT
4117	BR-1322-GT
4123	BL-1455-GT
4156	BR-2769-OT
4196	BR-2665-OT
4197	BR-2566-OT
4210	BS-2013-GD
4262	BR-15175-GD
4298	BS-8114-BD
31118	AD-1171-OT
31119	AL-66171-GT
31120	AR-0626-GT
31125	AL-2451-GT
31156	AL-62155-GT
31190	AS-0806-OT
31193	AD-0836-GT
31225	AS-61153-GT
31257	AL-44104-GT
31285	AD-0830-GT
31286	AD-0833-GT
31287	AD-0837-GT
31288	AD-0843-GT
31289	AD-0845-GT
31290	AL-0947-GT
31291	AL-0947-GT
31292	AT-08103-GT
31296	AD-0833-GT
32120	AR-0626-GD
32125	AL-2451-GD
32198	AR-100208-GD
32233	AS-8314-GD
32287	AD-0837-GD
37301	AR-57146-GD
37308	AR-50116-GD
37312	AR-29147-GD
37318	AR-50116-GD
41120	BR-4026-GT
41190	BS-2006-OT
41307	BR-20197-GT
42125	BL-2052-GD
42138	BR-20120-GD
42231	BS-20163-GD
42397	BS-9010-GD

Graph Paper Cross Reference

Dietzgen Instruments

Cross Reference To

Graphic Controls

Dietzgen No.	GC No.
309 G	RS-6406-GTR
309 R	RS-6406-OTR
340-1	AS-08169-GT
340-4	AS-0801-GT
340-5	AS-0802-GT
340-5-1/2	AS-0811-GT
340-6	AS-0803-GT
340-8	AS-0804-GT
340-10	AS-0807-GT
340-10-1/2	AS-0813-GT
340-10P	AS-0805-GT
340-12	AS-0808-GT
340-16	AS-0809-GT
340-20	AS-1110-GT
340-20L	AS-1110-GT
340-20P	AS-0810-GT
340-32	AR-0817-GT
340-CP	AC-03131-GT
340-DM	BS-8114-GT
340-L11	AL-0947-GT
340-L21	AL-0148-GT
340-L22	AL-0949-GT
340-L33	AL-0953-GT
340-L35	AL-0254-GT
340-L106	AD-0829-GT
340-L110	AD-0830-GT
340-L112	AD-08112-GT
340-L206	AD-0832-GT
340-L210	AD-0833-GT
340-L212	AD-0835-GT
340-L220	AD-0836-GT
340-L310	AD-0837-GT
340-L312	AD-0868-GT
340-L410	AD-0843-GT
340-L412	AD-2873-GT
340-L510	AD-0845-GT
340-M	AS-80177-GT
340-MP	AS-8014-GT
340-P	AC-0815-GT
340-PS90	AP-0756-GT
340-T3	AR-21111-GT
340-T6	AR-0320-GT
340-T9	AR-0886-GT
340-T21	AR-0524-GT
340-T24	AR-0525-GT
340-T30	AR-2199-GT
340-T33	AR-0626-GT
340-TC	AT-8216-GT
340A-5-1/2	AS-0811-GV
340A-8	AS-0860-GV
340A-10-1/2	AS-0813-GV

**Dietzgen Instruments
(Continued)**

Dietzgen No.	GC No.
340A-20	AS-1110-GV
340A-L22	AL-0949-GV
340A-L110	AD-0830-GV
340A-L210	AD-0833-GV
340A-L310	AD-0837-GV
340A-M	AS-8014-GV
340AN-10	AS-0807-BV
340AN-20	AS-1110-BV
340AR-5-1/2	AS-0811-OV
340AR-10	AS-0807-OV
340AR-10-1/2	AS-0813-OV
340D-5-1/2	BS-2011-GT
340D-6	BS-2003-GT
340D-8	BS-2004-GT
340D-10	BS-2007-GT
340D-10-1/2	BS-2013-GT
340D-12	BS-2008-GT
340D-20	BS-2010-GT
340D-34	BR-2018-GT
340D-35	BR-2094-GT
340D-38	BR-20120-GT
340D-L11	BL-17180-GT
340D-L22	BL-1850-GT
340D-L23	BL-2052-GT
340D-L35	BL-1455-GT
340D-L112	BD-2031-GT
340D-L212	BD-2070-GT
340D-L310	BD-2038-GT
340D-L312	BD-2039-GT
340D-M	BS-8114-GT
340D-MP	BS-8114-GT
340D-T12	BR-1623-GT
340D-T18	BR-1521-GT
340DA-10	BS-2007-GV
340DA-20	BS-2010-GV
340DA-M	BS-8114-GV
340DR-6	BS-2003-OT
340DR-8	BS-2004-OT
340DR-10	BS-2007-OT
340DR-10-1/2	BS-2013-OT
340DR-20	BS-2010-OT
340DR-L22	BL-1850-OT
340DR-L23	BL-2052-OT
340DR-L35	BL-1455-OT
340DR-L112	AD-2031-OT
340DR-L212	BD-2070-OT
340DR-L310	BD-2038-OT
340DR-L312	BD-2039-OT
340DR-MP	BS-8114-OT
340DR-T12	BR-1623-OT
340E-10-1/2	AS-0813-CT
340R-4	AS-0801-OT

**Dietzgen Instruments
(Continued)**

Dietzgen No.	GC No.
340R-5	AS-0802-OT
340R-5-1/2	AS-0811-OT
340R-8	AS-0804-OT
340R-10	AS-0807-OT
340R-10-1/2	AS-0813-OT
340R-12	AS-0808-OT
340R-16	AS-0809-OT
340R-20	AS-1110-GT
340R-L11	AL-0947-OT
340R-L21	AL-0148-OT
340R-L22	AL-0949-OT
340R-L33	AL-0953-OT
340R-L35	AL-0254-OT
340R-L110	AD-0830-OT
340R-L210	AD-0833-OT
340R-L220	AD-0836-OT
340R-L310	AD-0837-OT
340R-L312	AD-0868-OT
340R-L410	AD-0843-OT
340R-L510	AD-0845-OT
340R-LT1	AL-0947-OT
340R-M	AS-8014-OT
340R-MP	AS-8014-OT
340R-P	AC-0815-OT
340R-T6	AR-0320-OT
341-5-1/2	AS-0811-GD
341-8	AS-0804-GD
341-10	AS-0807-GD
341-10-1/2	AS-0813-GD
341-10P	AS-0805-GD
341-16	AS-0809-GD
341-20	AS-1110-GD
341-L11	AL-0947-GD
341-L22	AL-0949-GD
341-L33	AL-0953-GD
341-L110	AD-0830-GD
341-L112	AD-08112-GD
341-L210	AD-0833-GD
341-L212	AD-0835-GD
341-L310	AD-0837-GD
341-L312	AD-0868-GD
341-M	AS-8014-GD
341P	AC-0815-GD
341-T3	AR-21111-GD
341-T6	AR-0320-GD
341-T9	AR-0886-GD
341-T21	AR-0524-GD
341-T24	AR-0525-GD
341-T30	AR-2199-GD
341B-10-1/2	AS-0813-BT
341D-10	BS-2007-GD
341D-10-1/2	BS-2013-GD

**Dietzgen Instruments
(Continued)**

Dietzgen No.	GC No.
341D-20	BS-2010-GD
341D-L22	BL-1850-GD
341D-L23	BL-2052-GD
341D-L35	BL-1455-GD
341D-L212	BD-2070-GD
341D-L310	BD-2038-GD
341D-L312	BD-2039-GD
341D-M	BS-8114-GD
341D-T18	BR-1521-GD

B. H. Elliott Instruments

Cross Reference To

Graphic Controls

Elliott No.	GC No.
450-5	AS-0802-GD
450-8	AS-0804-GD
450-10	AS-0807-GD
450-12	AS-0808-GD
450-20	AS-0813-GD
450A-10	AS-0806-BD
450A-20	AS-0810-BD
450M	AS-8414-GD
451-5	BS-2002-GD
451-8	BS-2004-GD
451-10	BS-2007-GD
451-12	BS-2008-GD
451-20	BS-2013-GD
451A-10	BS-2006-GD
451A-20	BS-2010-GD
451M	BS-8114-GD
452-5	AS-0802-GT
452-8	AS-0804-GT
452-10	AS-0807-GT
452-12	AS-0808-GT
452-20	AS-0813-GT
452A-10	AS-0806-GT
452A-20	AS-0810-GT
452AE-10	AS-0806-OV
452AR-10	AS-0806-OT
452AR-20	AS-0810-OT
452E-10	AS-0807-OV
452E-20	AS-0813-OV
452EM	AS-8414-OV
452M	AS-8414-GT
452R-5	AS-0802-OT
452R-8	AS-0804-OT
452R-10	AS-0807-OT
452R-12	AS-0808-OT
452R-20	AS-0813-OT
453-5	BS-2002-GT
453-8	BS-2004-GT

**B. H. Elliott Instruments
(Continued)**

Elliott No.	GC No.
453-10	BS-2007-GT
453-12	BS-2008-GT
453-20	BS-2013-GT
453A-10	BS-2006-GT
453A-20	BS-2010-GT
453AE-10	BS-2006-OV
453AR-10	BS-2006-OT
453AR-20	BS-2010-OT
453E-10	BS-2007-OV
453E-20	BS-2013-OV
453EM	BS-8114-OV
453M	BS-8114-GT
453R-5	BS-2002-OT
453R-8	BS-2004-OT
453R-10	BS-2007-OT
453R-12	BS-2008-OT
453R-20	BS-2013-OT
453RM	BS-8114-OT
500	AL-0947-GD
501	AL-0947-GT
502	AL-0947-OT
509	BL-2052-GD
510	BL-2052-GT
511	BL-2052-OT
518	BL-1455-GD
519	BL-1455-GT
520	BL-1455-OT
550	AD-0833-GT
551	AD-0833-GD
558	AD-0837-GT
559	AD-0837-GD
564	AD-0843-GT
565	AD-0843-GD
570	AD-0845-GT
571	AD-0845-GD

**Graphic Controls Canada Ltd.
Instruments**

Cross Reference To

Graphic Controls

GC-Canada	GC-Buffalo
G8-6L	BS-2013-GD
G8-22	AP-0593-GD
G8-31	AC-0815-GD
G8-72L	BD-2039-GD
G8-82	AD-2873-OT
G8-941L	BD-2072-GD
G8-111	AL-1292-GD
G8-129	AR-41101-GD
G8-139	AR-0886-GD
G8-142	AR-3723-GD

**Graphic Controls Canada Ltd.
Instruments (Continued)**

GC-Canada	GC-Buffalo
G8-175	AD-3889-OT
G8-190	AR-2881-GD
G8-192L	BR-4026-GD
G8-200L	BR-2769-GD
G8-240	AR-3583-GD
G8-10055	AG-0867-GD
G9-9-1/2	AS-0809-OT
G9-9-1/2L	BS-2012-OT
G9-14L	BS-8114-GD
G9-14L	BS-8114-GV
G9-16L	BR-2094-OT
G9-22	AP-0593-GT
G9-27B	AF-43102-BT
G9-28LB	BR-2097-BT
G9-31	AC-0815-OT
G9-31G	AC-0815-GT
G9-32G	AT-8216-GT
G9-52	AD-2031-OT
G9-62L	BN-2070-GD
46-0000	AN-0000-ND
G9-64	AD-1171-OT
G9-66	AR-0599-OT
G9-72	AD-0868-OT
G9-82	AD-2873-OT
G9-91	AD-0845-OT
G9-91LG	BD-2078-GT
G9-94L	BD-2072-OT
G9-99	AD-3991-OT
G9-111	AL-1292-OT
G9-126	AL-0254-GT
G9-190	AR-2881-OT
G9-192L	BR-4026-OT
G9-200L	BR-2769-OT
G9-210L	BR-2786-OT
GC8-48	AR-3887-GD
GC8-66	AR-0599-GD
GC9-48	AR-3887-OT

**Heuffel & Esser Instruments
(Continued)**

K & E No.	GC No.
46-0210	AC-03131-GD
46-0213	AC-03131-OT
46-0250	AS-0801-GD
46-0253	AS-0801-OT
46-0410	AS-0802-GD
46-0412	AS-0802-GT
46-0413	AS-0802-OT
46-0421	AS-0802-BD
46-0460	AS-0803-GD
46-0463	AS-0803-OT
46-0540	AS-0804-GD
46-0542	AS-0804-GT
46-0543	AS-0804-OT
46-0620	AS-08107-GD
46-0622	AS-08107-GT
46-0660	AS-0805-GD
46-0663	AS-0805-OT
46-0700	AS-0806-GD
46-0701	AS-0806-BD
46-0702	AS-0806-GT
46-0703	AS-0806-OT
46-0705	AS-0806-OH
46-0706	AS-0806-GV
46-0707	AS-0806-OV
46-0708	AS-0806-BV
46-0780	AS-0807-GD
46-0782	AS-0807-GT
46-0860	AS-0811-GD
46-0862	AS-0811-GT
46-0863	AS-0811-OT
46-0865	AS-0811-OH
46-0866	AS-0811-GV
46-0867	AS-0811-OV
46-0940	AS-0808-GD
46-0943	AS-0808-OT
46-1020	AS-1164-GD
46-1022	AS-1164-OT
46-1080	AS-0809-GD
46-1083	AS-0809-OT
46-1120	AS-0812-GD
46-1123	AS-0812-OT
46-1200	AS-08108-GD
46-1203	AS-08108-OT
46-1240	AS-0810-GD
46-1242	AS-0810-GT
46-1320	AS-0813-GD
46-1322	AS-0813-GT
46-1323	AS-0813-OT
46-1325	AS-0813-OH
46-1326	AS-0813-GV
46-1327	AS-0813-OV
46-1331	AS-0813-BD

**Heuffel & Esser Instruments
(Continued)**

K & E No.	GC No.
46-1332	AS-0813-CT
46-1333	AS-0813-BT
46-1430	AS-2113-GD
46-1432	AS-2113-GT
46-1470	AS-1113-GD
46-1472	AS-1113-GT
46-1473	AS-1113-OT
46-1475	AS-1113-OH
46-1476	AS-1113-GV
46-1477	AS-1113-OV
46-1510	AS-8014-GD
46-1512	AS-8014-GT
46-1513	AS-8014-OT
46-1515	AS-8014-OH
46-1516	AS-8014-GV
46-1517	AS-8014-OV
46-1521	AS-8014-BD
46-1523	AS-8014-BT
46-1610	AS-8584-GD
46-1612	AS-8584-GT
46-1620	AS-8584-CD
46-1650	AR-3685-GD
46-1653	AR-3685-OT
46-1657	AR-3685-OV
46-1770	AR-36109-GD
46-1773	AR-36109-OT
46-1930	AR-0817-GD
46-1933	AR-0817-OT
46-1970	AR-0818-GD
46-1973	AR-0818-OT
46-2050	AR-41110-GD
46-2053	AR-41110-OT
46-2090	AR-21111-GD
46-2092	AR-21111-GT
46-2093	AR-21111-OT
46-2290	AR-0320-GD
46-2292	AR-0320-GT
46-2293	AR-0320-OT
46-2410	AR-51115-GD
46-2413	AR-51115-OT
46-2610	AR-0886-GD
46-2613	AR-0886-OT
46-2890	AR-3723-GD
46-2893	AR-3723-OT
46-3010	AR-0524-GD
46-3013	AR-0524-OT
46-3090	AR-0425-GD
46-3093	AR-0425-OT
46-3170	AR-3887-GD
46-3173	AR-3887-OT
46-3290	AR-2199-GD
46-3293	AR-2199-OT

**Heuffel & Esser Instruments
(Continued)**

K & E No.	GC No.
46-3410	AR-4881-GD
46-3413	AR-4881-OT
46-3650	AR-0626-GD
46-3653	AR-0626-OT
46-3970	AR-46132-GD
46-3972	AR-46132-GT
46-4110	AR-0827-GD
46-4113	AR-0827-OT
46-4231	AR-0828-BD
46-4243	AR-0828-BT
46-4361	AZ-43102-BD
46-4373	AZ-43102-BT
46-4410	AC-0815-GD
46-4412	AC-0815-GT
46-4413	AC-0815-OT
46-4416	AC-0815-GV
46-4417	AC-0815-OT
46-4453	AC-08133-OT
46-4490	AT-8216-GD
46-4492	AT-8216-GT
46-4493	AT-8216-OT
46-4530	AD-0829-GD
46-4533	AD-0829-OT
46-4650	AD-0830-GD
46-4652	AD-0830-GT
46-4653	AD-0830-OT
46-4656	AD-0830-GV
46-4657	AD-0830-OV
46-4770	AD-08112-GD
46-4773	AD-08112-OT
46-4850	AD-0832-GD
46-4853	AD-0832-OT
46-4970	AD-0833-GD
46-4972	AD-0833-GT
46-4973	AD-0833-OT
46-4976	AD-0833-GV
46-4977	AD-0833-OV
46-5050	AD-0835-GD
46-5053	AD-0835-OT
46-5130	AD-0836-GD
46-5132	AD-0836-GT
46-5133	AD-0836-OT
46-5250	AD-1171-GD
46-5253	AD-1171-OT
46-5370	AD-0888-GD
46-5373	AD-0888-OT
46-5490	AD-0837-GD
46-5492	AD-0837-GT
46-5493	AD-0837-OT
46-5501	AD-0837-BD
46-5506	AD-0837-GV
46-5507	AD-0837-OV

**Heuffel & Esser Instruments
(Continued)**

K & E No.	GC No.
46-5730	AD-0868-GD
46-5733	AD-0868-OT
46-5810	AD-0840-GD
46-5813	AD-0840-OT
46-5890	AD-0842-GD
46-5893	AD-0842-OT
46-6010	AD-0843-GD
46-6012	AD-0843-GT
46-6013	AD-0843-OT
46-6090	AD-2873-GD
46-6093	AD-2873-OT
46-6210	AD-0845-GD
46-6212	AD-0845-GT
46-6213	AD-0845-OT
46-6290	AD-21118-GD
46-6292	AD-21118-GT
46-6293	AD-21118-OT
46-6460	AD-2346-GD
46-6463	AD-2346-OT
46-6640	AD-3889-GD
46-6643	AD-3889-OT
46-6690	AD-85124-GD
46-6693	AD-85124-OT
46-6882	AD-2190-GT
46-6920	AD-47134-GD
46-6923	AD-47134-OT
46-6960	AD-3991-GD
46-6963	AD-3991-OT
46-7000	AL-0947-GD
46-7002	AL-0947-GT
46-7003	AL-0947-OT
46-7080	AL-0148-GD
46-7083	AL-0148-OT
46-7200	AL-0949-GD
46-7202	AL-0949-GT
46-7203	AL-0949-OT
46-7206	AL-0949-GV
46-7207	AL-0949-OV
46-7280	AL-1292-GD
46-7282	AL-1292-GT
46-7283	AL-1292-OT
46-7320	AL-2451-GD
46-7322	AL-2451-GT
46-7323	AL-2451-OT
46-7400	AL-0953-GD
46-7402	AL-0953-GT
46-7403	AL-0953-OT
46-7410	AL-0953-BT
46-7520	AL-0254-GD
46-7522	AL-0254-GT
46-7523	AL-0254-OT
46-7602	AL-02127-GT

Heuffel & Esser Instruments

Cross Reference To
Graphic Controls

K & E No.	GC No.
46-0002	AN-0000-NT
46-0020	AR-3583-GD
46-0060	AR-50116-GD
46-0090	AC-01128-GD
46-0130	AR-11129-GD
46-0133	AR-11129-OT
46-0140	AR-53129-GD
46-0143	AR-53129-OT

**Heuffel & Esser Instruments
(Continued)**

K & E No.	GC No.
46-7800	AL-2974-GD
46-7802	AL-2974-GT
46-7960	AL-31135-GD
46-7963	AL-31135-OT
46-8000	AP-0756-GD
46-8003	AP-0756-OT
46-8040	AP-1057-GD
46-8043	AP-1057-OT
46-8080	AP-0593-GD
46-8082	AP-0593-GT
46-8120	AH-11113-GD
46-8123	AH-11113-OT
46-8200	AH-48137-GD
46-8203	AH-48137-OT
46-8242	AH-49138-GT
46-8282	AH-49139-GT
46-8322	AD-08140-GT
47-0460	BS-2003-GD
47-0463	BS-2003-OT
47-0540	BS-2004-GD
47-0543	BS-2004-OT
47-0700	BS-2006-GD
47-0702	BS-2006-GT
47-0703	BS-2006-OT
47-0706	BS-2006-GV
47-0707	BS-2006-OV
47-0780	BS-2007-GD
47-0782	BS-2007-GT
47-0786	BS-2007-GV
47-0860	BS-2011-GD
47-0862	BS-2011-GT
47-0940	BS-2008-GD
47-0942	BS-2008-GT
47-0943	BS-2008-OT
47-1020	BS-2064-GD
47-1022	BS-2064-OT
47-1120	BS-2012-GD
47-1123	BS-2012-OT
47-1240	BS-2010-GD
47-1242	BS-2010-GT
47-1243	BS-2010-OT
47-1320	BS-2013-GD
47-1322	BS-2013-GT
47-1323	BS-2013-OT
47-1326	BS-2013-GV
47-1327	BS-2013-OV
47-1510	BS-8114-GD
47-1512	BS-8114-GT
47-1513	BS-8114-OT
47-1516	BS-8114-GV
47-1517	BS-8114-OV
47-1650	BR-2094-GD

**Heuffel & Esser Instruments
(Continued)**

K & E No.	GC No.
47-1653	BR-2094-OT
47-1770	BR-20119-GD
47-1773	BR-20119-OT
47-1810	BR-20121-GD
47-1817	BR-20121-OV
47-1850	BR-20120-GD
47-1970	BR-2018-GD
47-1973	BR-2018-OT
47-2250	BR-1919-GD
47-2253	BR-1919-OT
47-2530	BR-2665-GD
47-2533	BR-2665-OT
47-2570	BR-2566-GD
47-2573	BR-2566-OT
47-2730	BR-1521-GD
47-2733	BR-1521-OT
47-2810	BR-1322-GD
47-2812	BR-1322-GT
47-2813	BR-1322-OT
47-2890	BR-1623-GD
47-2893	BR-1623-OT
47-2970	BR-1595-GD
47-2973	BR-1595-OT
47-3650	BR-4026-GD
47-3653	BR-4026-OT
47-3730	BR-2769-GD
47-3732	BR-2769-GT
47-3733	BR-2769-OT
47-3850	BR-2796-GD
47-3853	BR-2796-OT
47-4030	BR-2097-GD
47-4032	BR-2097-GT
47-4043	BR-2097-OT
47-4770	BD-2031-GD
47-4773	BD-2031-OT
47-4970	BD-2034-GD
47-4972	BD-2034-GT
47-4973	BD-2034-OT
47-5050	BD-2070-GD
47-5053	BD-2070-OT
47-5490	BD-2038-GD
47-5492	BD-2038-GT
47-5493	BD-2038-OT
47-5730	BD-2039-GD
47-5732	BD-2039-GT
47-5733	BD-2039-OT
47-5810	BD-2041-GD
47-5812	BD-2041-GT
47-5813	BD-2041-OT
47-6010	BD-2044-GD
47-6012	BD-2044-GT
47-6013	BD-2044-OT

**Heuffel & Esser Instruments
(Continued)**

K & E No.	GC No.
47-6210	BD-2078-GD
47-6212	BD-2078-GT
47-6420	BD-2072-GD
47-6423	BD-2072-OT
47-6490	BD-20154-GD
47-6492	BD-20154-GT
47-6540	BD-15123-GD
47-6543	BD-15123-OT
47-6590	BD-15123-GD
47-6593	BD-15123-OT
47-6740	BD-4079-GD
47-6743	BD-4079-OT
47-6790	BD-27125-GD
47-6793	BD-27125-OT
47-6840	BD-27126-GD
47-6843	BD-27126-OT
47-7000	BL-1747-GD
47-7003	BL-1747-OT
47-7200	BL-1850-GD
47-7203	BL-1850-OT
47-7320	BL-2052-GD
47-7322	BL-2052-GT
47-7323	BL-2052-OT
47-7520	BL-1455-GD
47-7522	BL-1455-GT
47-7523	BL-1455-OT
47-7920	BL-3075-GD
47-7922	BL-3075-GT
47-8062	BP-18136-GT
47-8120	BH-20114-GD
47-8123	BH-20114-OT
48-5010	US-9311-OT
48-5050	XS-9463-ES
48-5098	RS-6406-GTR
48-5100	RS-6406-OTR
48-5147	GS-5813-GD
48-5150	GS-5813-GT
48-5153	HS-1113-GD
48-5156	HS-1113-BD
48-5162	HS-1113-GT
48-5165	HS-1113-BT
48-5168	HS-1113-OT
48-5174	KS-2013-GD
48-5177	KS-2013-GT
48-5180	KS-2013-OT
48-5227	ER-45151-OT
48-5232	OR-60152-GT
48-5247	LL-86148-GD
48-5257	ML-59149-GT
48-5258	BL-59149-GT
359-35	AC-03131-OT

Lietz Instruments

Cross Reference To

Graphic Controls

Lietz No.	GDC No.
910-23	AS-8014-GD
910-37	AC-0815-GD
910-41	AD-0830-GD
910-43	AD-0833-GD
910-55	AL-0947-GD
910-57	AL-0949-GD
910-61	AL-0953-GD
911-8	AS-0804-OT
911-10	AS-0806-OT
911-12	AS-0807-OT
911-18	AS-0810-OT
911-20D	BS-2010-OT
911-24	AS-8014-OT
911-26D	BS-8114-OT
911-38	AC-0815-OT
911-42	AD-0830-OT
911-44	AD-0833-OT
911-56	AL-0947-OT
911-58	AL-0949-OT
1708-12	AS-0804-OT
1710-12	AS-0806-OT
1711-12	AS-0807-OT
1721-12	AS-0810-OT
1721-42	BS-2010-OT
1723-01	AS-8014-GD
1723-12	AS-8014-OT
1723-42	BS-8114-OT
1741-01	AD-0830-GD
1741-12	AD-0830-OT
1743-01	AD-0833-GD
1743-12	AD-0833-OT
1755-01	AL-0947-GD
1755-21	AL-0947-OT
1757-01	AL-0949-GD
1757-12	AL-0949-OT
1761-01	AL-0953-GD
1787-01	AC-0815-GD
1787-12	AC-0815-OT

**Graph Paper
Cross Reference**

Universal Series Disposable Marking Systems

Industrial Monitoring Solutions

Graphic Controls has products to fit virtually all recorders in use today. We can offer a line of Universal disposable pens, pen arms and bulk ink which have found wide acceptance among many instrument OEMs.





Most disposable pens are originally designed for a single instrument or application. Many times, features are so customized to a specific instrument that the pen cannot be readily adapted to other applications. The designs featured here, however, have virtually become industry standards! Our Series 09, 11, 12 and 13 are used extensively in strip chart applications. Our Series 39 disposable pens were designed to be used on virtually all circular chart recorders; the snap-on feature works in a variety of normal flat and wire pens arms.

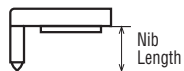

We also supply a wide variety of pen arms. Our Series 72 and 79 pens meet or exceed AGA standards for scannability and gas patch performance. We can deliver these stocked items within days of your order receipt from strategically located distribution centers throughout North America.



Nib Length

For your reference, nib length is measured as shown.

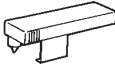
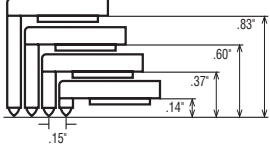

Description	To Fit	Key	Size	Per Pack	Color	Order By Number
Universal Series 07™	Strip Chart Recorders	 MP 002P	.760" nib	5 pens	Black	MP 82-07-0041-05
					Red	MP 82-07-0042-05
					Blue	MP 82-07-0043-05
					Green	MP 82-07-0044-05
Universal Series 09™	Strip Chart Recorders	 MP 004P	.200" nib	5 pens	Black	MP 82-09-0161-05
					Red	MP 82-09-0162-05
					Blue	MP 82-09-0163-05
					Green	MP 82-09-0164-05
			.265" nib	5 pens	Black	MP 82-09-0201-05
					Red	MP 82-09-0202-05
					Blue	MP 82-09-0203-05
					Green	MP 82-09-0204-05
Universal Series 11™	Strip Chart Recorders	 MP 006P	.464" nib	5 pens	Black	MP 82-11-0011-05
					Red	MP 82-11-0012-05
					Blue	MP 82-11-0013-05
					Green	MP 82-11-0014-05
Universal Series 12™	Strip Chart Recorders	 MP 006P	.156" nib	5 pens	Black	MP 82-12-0211-05
					Red	MP 82-12-0212-05
					Blue	MP 82-12-0213-05
					Green	MP 82-12-0214-05
			.194" nib	5 pens	Black	MP 82-12-0391-05
					Red	MP 82-12-0392-05
					Blue	MP 82-12-0393-05
					Green	MP 82-12-0394-05
			.250" nib	5 pens	Black	MP 82-12-0271-05
					Red	MP 82-12-0272-05
					Blue	MP 82-12-0273-05
					Green	MP 82-12-0274-05
.321" nib	5 pens	Black	MP 82-12-0431-05			
		Red	MP 82-12-0432-05			
		Blue	MP 82-12-0433-05			
		Green	MP 82-12-0434-05			
.417" nib	5 pens	Black	MP 82-12-0441-05			
		Red	MP 82-12-0442-05			
		Blue	MP 82-12-0443-05			
		Green	MP 82-12-0444-05			
.430" nib	5 pens	Black	MP 82-12-0401-05			
		Red	MP 82-12-0402-05			
		Blue	MP 82-12-0403-05			
		Green	MP 82-12-0404-05			

Description	To Fit	Key	Size	Per Pack	Color	Order By Number
Universal Series 12™ (Continued)	Strip Chart Recorders	 MP 006P	.464" nib	5 pens	Black Red Green	MP 82-12-0221-05 MP 82-12-0222-05 MP 82-12-0224-05
			.490" nib	5 pens	Black Red Blue Green	MP 82-12-0261-05 MP 82-12-0262-05 MP 82-12-0263-05 MP 82-12-0264-05
			.562" nib	5 pens	Black Red Blue Green	MP 82-12-0471-05 MP 82-12-0472-05 MP 82-12-0473-05 MP 82-12-0474-05
			.610" nib	5 pens	Black Red Blue Green	MP 82-12-0341-05 MP 82-12-0342-05 MP 82-12-0343-05 MP 82-12-0344-05
			.749" nib	5 pens	Black Red Blue Green	MP 82-12-0041-05 MP 82-12-0042-05 MP 82-12-0043-05 MP 82-12-0044-05
			.764" nib	5 pens	Black Red Blue Green	MP 82-12-0231-05 MP 82-12-0232-05 MP 82-12-0233-05 MP 82-12-0234-05
			.970" nib	5 pens	Black Red Blue Green	MP 82-12-0351-05 MP 82-12-0352-05 MP 82-12-0353-05 MP 82-12-0354-05
Universal Series 13™	Strip Chart Recorders	 MP 006P	.156" nib	5 pens	Black Red Blue Green	MP 82-13-0041-05 MP 82-13-0042-05 MP 82-13-0043-05 MP 82-13-0044-05
			.250" nib	5 pens	Black Red Blue Green	MP 82-13-0231-05 MP 82-13-0232-05 MP 82-13-0233-05 MP 82-13-0234-05
Universal Series 32™	Strip Chart Recorders	 MP 206P	.140" nib	5 pens	Red Green	MP 82-32-0312-05 MP 82-32-0314-05
			.400" nib	5 pens	Red	MP 82-32-0322-05
			.650" nib	5 pens	Red Green	MP 82-32-0332-05 MP 82-32-0334-05

Description	To Fit	Key	Size	Per Pack	Color	Order By Number
Universal Series 39™ Temperature Operating Range: -20°F to 135°F 	Circular Chart Recorders	 MP 012P	.140" nib	6 pens	Black Red Blue Green Purple	MP 82-39-0101-06 MP 82-39-0102-06 MP 82-39-0103-06 MP 82-39-0104-06 MP 82-39-0106-06
			.370" nib	6 pens	Black Red Blue Green Purple	MP 82-39-0201-06 MP 82-39-0202-06 MP 82-39-0203-06 MP 82-39-0204-06 MP 82-39-0206-06
			.600" nib	6 pens	Black Red Blue Green Purple	MP 82-39-0301-06 MP 82-39-0302-06 MP 82-39-0303-06 MP 82-39-0304-06 MP 82-39-0306-06
			.830" nib	6 pens	Black Red Blue Green Purple	MP 82-39-0401-06 MP 82-39-0402-06 MP 82-39-0403-06 MP 82-39-0404-06 MP 82-39-0406-06
Universal Series 60™ Temperature Operating Range: -20°F to 135°F 	Circular Chart Recorders	 MP 015P	.140" nib	6 pens	Black Red Blue Green Purple	MP 82-60-0011-06 MP 82-60-0012-06 MP 82-60-0013-06 MP 82-60-0014-06 MP 82-60-0016-06
			.370" nib	6 pens	Black Red Blue Green Purple	MP 82-60-0021-06 MP 82-60-0022-06 MP 82-60-0023-06 MP 82-60-0024-06 MP 82-60-0026-06
			.600" nib	6 pens	Black Red Blue Green Purple	MP 82-60-0031-06 MP 82-60-0032-06 MP 82-60-0033-06 MP 82-60-0034-06 MP 82-60-0036-06
			.830" nib	6 pens	Black Red Blue Green Purple	MP 82-60-0041-06 MP 82-60-0042-06 MP 82-60-0043-06 MP 82-60-0044-06 MP 82-60-0046-06

Broad Line Pens for Scanner Processed Charts

Series 72™ and 79™ Scannable Pens are designed to produce consistently clean, scannable charts.

- Broader line width assures reliable scanner processing
- Exclusive Graphic Controls inks virtually eliminate skips and estimations
- Hi Range or Lo Range ink insures a solid, scannable trace in all types of climates

Fine Line Pens for Integrator Processed Charts





Series 72™ and 79™ Fine Line Pens for Integrators offer performance advantages to gas industry companies that process their charts manually.

- Fine-point pen tips for more sharply defined lines
- Thinner lines allow integrator operators to trace the flow of gas more accurately

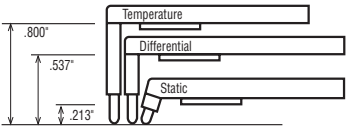
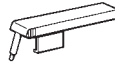
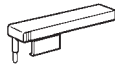
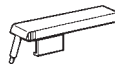
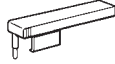
Universal Series 72™ and 79™

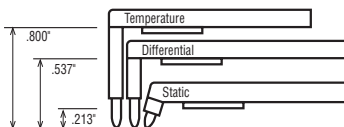
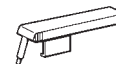
These Universal Series disposable pens are used primarily with instrumentation found in the gas flow measurement industry. Pen arrays can be calibrated to a 15 minute time tag (.090") between Differential and Static pens on the Zero line of a 24 hour chart.

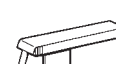
Description	To Fit	Key	Size	Per Pack	Color	Order By Number	
Series 72™ and 79™ Broad Line Pens 							
Array "A" Static Measurement	Barton, Rockwell 3-Pen recorders	 MP 016P	.213" nib	6 pens	Black/LO Blue/LO Black/HI Blue/HI	MP 82-72-0151-06 MP 82-72-0153-06 MP 82-72-0161-06 MP 82-72-0163-06	
Array "A" Differential Measurement			 MP 025P	.537" nib	6 pens	Red/LO Red/HI	MP 82-79-0253-06 MP 82-79-0163-06
Array "A" Temperature Measurement				.800" nib	6 pens	Scan Green/LO Green/HI Nonscan Green/LO Green/HI	MP 82-79-0454-06 MP 82-79-0464-06 MP 82-79-145N-06 MP 82-79-146N-06
Array "B" Temperature Measurement	American Meter, Foxboro, Mercury 3-Pen recorders	 MP 016P	.237" nib	6 pens	Scan Green/LO Green/LO Nonscan Green/LO Green/HI	MP 82-72-0154-06 MP 82-72-0164-06 MP 82-72-115N-06 MP 82-72-116N-06	
Array "B" Static Measurement			 MP 025P	.505" nib	6 pens	Scan Black/LO Blue/LO Black/HI Blue/HI	MP 82-72-0251-06 MP 82-72-0253-06 MP 82-72-0261-06 MP 82-72-0263-06
Array "B" Temperature Measurement				.800" nib	6 pens	Scan Red/LO Red/HI	MP 82-79-0452-06 MP 82-79-0462-06

Description	To Fit	Key	Size	Per Pack	Color	Order By Number
Series 72™ and 79™ Fine Line Pens 						
Array "A" Static Measurement*	Barton, Rockwell 3-Pen recorders	 MP 016P	.213" nib	6 pens	Black/LO Blue/LO Black/HI Blue/HI	MP 82-72-3151-06 MP 82-72-3153-06 MP 82-72-3161-06 MP 82-72-3163-06
Array "A" Differential Measurement*		 MP 025P	.537" nib	6 pens	Red/LO Red/HI	MP 82-79-3352-06 MP 82-79-3362-06
Array "A" Temperature Measurement*		 MP 025P	.800" nib	6 pens	Green/LO Green/HI	MP 82-79-3454-06 MP 82-79-3464-06
Array "B" Temperature Measurement	American Meter, Foxboro, Mercury 3-Pen recorders	 MP 016P	.213" nib	6 pens	Green/LO Green/HI	MP 82-72-3154-06 MP 82-72-3164-06
Array "B" Static Measurement		 MP 016P	.505" nib	6 pens	Black/LO Blue/LO Black/HI Blue/HI	MP 82-72-3251-06 MP 82-72-3253-06 MP 82-72-3261-06 MP 82-72-3263-06
Array "B" Differential Measurement		 MP 025P			Red/HI	MP 82-79-3462-06





* **Note:** Ink Temperature Operating Ranges – HI Temp Ink optimal range +20°F to 120°F, Lo Temp optimal Range -40°F to 90°F
 Single Temp Ink Optimal Range +35°F to 100°F





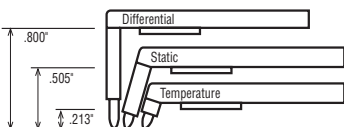
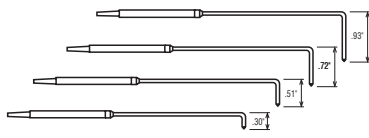
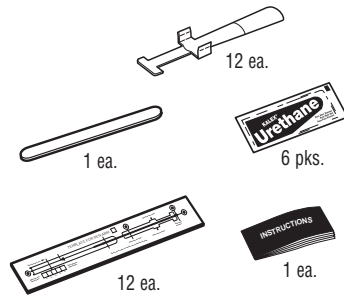
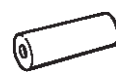
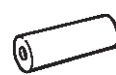



Replacement Pen Arms put Disposable Pens to Work for You





Graphic Controls Replacement Pen Arms allow you to quickly convert a recorder needing constant attention to a cost efficient, easy to maintain disposable pen writing system.

Designed specifically to mate with Graphic Controls most popular and technically advanced disposable pen, the Series 39™, our replacement arms make conversion a snap. By simply pressing the pen down on the arm, snapping the hinge, a tight lock-up is achieved for precise tip registration and lateral pen stability. Also, each pen arm has been individually engineered to fit a specific model recorder. This assures that you have no difficulty replacing the arm on your recorder.

If you have a recorder for which no Graphic Controls replacement pen arm has been manufactured, use the Pen Arm Conversion Kit. This kit allows you to convert twelve existing pen arms to accept Series 39™ disposable pens.

Description	To Fit	Key	Size	Per Pack	Color	Order By Number
Universal Series 76™ 	Strip Chart Recorders	 MP 011P	.300" nib .510" nib .720" nib .930" nib	3 pens	Red Blue Green Purple	MP 82-76-1002-03 MP 82-76-2003-03 MP 82-76-3004-03 MP 82-76-4006-03
Universal Series 77™	Strip Chart Recorders	<i>See Series 76™ above.</i> MP 025P	.300" nib .510" nib .720" nib .930" nib	3 pens	Red Blue Green Purple	MP 82-77-1002-03 MP 82-77-2003-03 MP 82-77-3004-03 MP 82-77-4006-03
Universal Pen Arm Kit Permits on-site retrofitting of virtually any style original equipment pen arm without the need to replace the complete pen arm.	Circular Chart Recorders	 MP 030	—	1 Kit/Pack: 12 Pen Arm Clips, 6 Pks. Urethane Adhesive, 1 Stirring Stick, Instructions, 12 Templates		MP 80-09-0180-01
Universal Ink Cartridges Fast Drying	—	 MP 021P	2.6cc	4 Cartridges	Black Red Blue Green Purple	MP 81-10-0341-04 MP 81-10-0342-04 MP 81-10-0343-04 MP 81-10-0344-04 MP 81-10-0346-04
Slow Drying	—	 MP 021P	2.6cc	4 Cartridges	Black Red Blue Green Purple	MP 81-10-0011-04 MP 81-10-0012-04 MP 81-10-0013-04 MP 81-10-0014-04 MP 81-10-0016-04
Fast Drying	—	 MP 022P	3.2cc	4 Cartridges	Black Red Blue Green Purple	MP 81-10-0071-04 MP 81-10-0072-04 MP 81-10-0073-04 MP 81-10-0074-04 MP 81-10-0076-04
Slow Drying	—	 MP 022P	3.2cc	4 Cartridges	Black Red Blue Green Purple	MP 81-10-0021-04 MP 81-10-0022-04 MP 81-10-0023-04 MP 81-10-0024-04 MP 81-10-0026-04
Fast Drying	—	 MP 023P	6.5cc	4 Cartridges	Black Red Blue Green Purple	MP 81-10-0191-04 MP 81-10-0192-04 MP 81-10-0193-04 MP 81-10-0194-04 MP 81-10-0196-04

Description	To Fit	Key	Size	Per Pack	Color	Order By Number
Universal Ink Cartridges (Continued) Slow Drying	-	 MP 023P	6.5cc	4 Cartridges	Black	MP 81-10-0011-04
					Red	MP 81-10-0012-04
					Blue	MP 81-10-0013-04
					Green	MP 81-10-0014-04
					Purple	MP 81-10-0026-04
Universal Bulk Recording Ink Fast Drying For humid conditions, +30°F to +100°F	Various Recorders	 INK 001	1 oz.	1	Black	INK 71-10-0161-01
					Red	INK 71-10-0162-01
					Blue	INK 71-10-0163-01
		 INK 016	16 oz.	1	Black	INK 71-50-0161-01
					Red	INK 71-50-0162-01
					Blue	INK 71-50-0163-01
		 INK 032	32 oz.	1	Black	INK 71-60-0161-01
					Red	INK 71-60-0162-01
					Blue	INK 71-60-0163-01
Medium Drying For standard use, +10°F to +110°F	Various Recorders	 INK 001	1 oz.	1	Black	INK 71-10-0141-01
					Red	INK 71-10-0142-01
					Blue	INK 71-10-0143-01
		 INK 016	16 oz.	1	Black	INK 71-50-0141-01
					Red	INK 71-50-0142-01
					Blue	INK 71-50-0143-01
		 INK 032	32 oz.	1	Black	INK 71-60-0141-01
					Red	INK 71-60-0142-01
					Blue	INK 71-60-0143-01
		 INK 128	1 gal.	1	Blue	INK 71-70-0143-01
					Green	INK 71-70-0144-01

Description	To Fit	Key	Size	Per Pack	Color	Order By Number
Universal Bulk Recording Ink (Continued) Slow Drying For hot, dry conditions, -15°F to +130°F	Various Recorders	 INK 001	1 oz.	1	Black Red Blue Green Purple	INK 71-10-0081-01 INK 71-10-0082-01 INK 71-10-0083-01 INK 71-10-0084-01 INK 71-10-0086-01
		 INK 016	16 oz.	1	Red Green Purple	INK 71-50-0082-01 INK 71-50-0084-01 INK 71-50-0086-01
		 INK 032	32 oz.	1	Red Blue Green	INK 71-60-0082-01 INK 71-60-0083-01 INK 71-60-0084-01
Low Temperature Non-freeze, for cold conditions, wide range use, -30°F to +140°F	Various Recorders	 INK 001	1 oz.	1	Red Blue Green Purple	INK 71-10-0092-01 INK 71-10-0093-01 INK 71-10-0094-01 INK 71-10-0096-01
		 INK 128	1 gal.	1	Blue Green	INK 71-70-0093-01 INK 71-70-0094-01

How Disposable Pens Help Trim Operating Costs

Finding ways to cut operating costs is good business. One place to look is the writing system on your recorders.

The use of disposable pens on your recorders is cost effective because disposable pens are convenient and easy to maintain. They can be quickly replaced by anyone and there is no need for constant cleaning or recalibration after each change. They also cut costs because of their reliability. They don't clog or skip and tend not to blot. They write equally well at temperatures from -20°F to 135°F. Their line quality is excellent and their write out distance is constant. And they have a shelf life of at least one year.

Additional Instrument Manufacturers

.....

Graphic Controls also produces Recorder Supplies to fit the manufacturers listed here. Contact your Customer Service Representative to order.

USA

Buffalo, New York
800 669-1535
Fax: 800 347-2420

Canada

Gananoque, Ontario
800 267-9498
Fax: 800 267-4521

International (Europe, Middle East)

Controles Gráficos
Ibéricos, S.A.
Tel: 34 91 7470444
Fax: 34 91 7477846

International (All Other Countries)

Tel: 716 847-7582
Fax: 716 847-7551

ACT Electronics	Biologic	Critikon	EPC Labs
Acurex	Biomolecular Separations	Crosby	Epsco
Adams	Biotronik	Cross & Trecker	Epson
Adcole	Birtcher	Cryomed	Etymotic Research
Adler Royal	Blanford	Curken Scientific	Exploration Logging
Alcon Laboratories	Bolton Emerson	Curtiss Wright	Exxon
Alden	Bowmar	Cutler Hammer	Federal Paper Board
Alina	BPB Industries	Dairy Test Equipment	Federal Products
Alkar	Brabender	Dallons	Fellows
Alphacom	Brainard	Dalmo Victor	Fellows Gear Shaper
Ambu	Brandt Industries Ltd.	Data Products	Ferris
American Analog	Brattle Instrument	Datamart	Filtronics
American Edwards Labs	Brentwood	Datametrics	Finn-Aqua
American Hospital Supply	Breon Laboratories, Inc.	Datascope	Finnigan Corp.
American Instrument	Brinkman	Datel	Fireye
American Oerlikon Gear	Brother	Debro	Fisher
American Optical	Brown & Sharpe	Decca-Elac	Fisher Scientific
American Sigma	Browne	Dektor	FLC Industries
Amoco	Bruel & Kjaer	Delta-X	Food Technology
Amrein Apparati	Bruker Instruments	Deltatrak	Forney
Anderson Jacobson	Bruning	Derma-Therm	Fotec
Andrew	Bryans Southern	Desa	Fredericks Co.
ANR Pipeline	Buck Scientific	Dezurik	Freyne
Anritsu	Burdick	Diano	Frye
Apelco	Burroughs	Digilab	Fuji Seimitsu
Appalachian Electronics	C.E. Johansson	Dillard	Fuji-Kiki
Apple Computer	Cabela's	Dohrmann Instruments	Fujitsu
Applied Physics	Calgon	Dowty	Fukuda Denshi
Applied Research Lab	Cambridge Instruments	Draper	Galiso "Hydraclose"
Applied Science Lab	Canadian Meter	Drayton	Gelman Instruments
Arcco-Anubis	Canlab	Drillograph	Gem Marine
Arkon	Cardioline	DTR Co.	Gemtronics
Ashton Wheel	Carrier Transicold	DuPont	General Railway Signal
Assembly Products	Casella London	Duro	Genrad
Associated Research	Castle	Dyna Empire	Gerbrand
Astrodyne	Caterpillar Tractor	Dynatron	Godart Pulmotest
Atkins Technical	Centronics	Dynetics	Gow-Mac
Atlantek	Chamont Granat	E & K Scientific	Graphotest
Atlas Electric Devices	Chevron Oil	E&M Instrument	Great Lakes
Atomic Accessories	Chickmaster Incubator	E.H. Replogle	Groux Mercurius
Auto Emission Trace	Cincinnati Clock	E.R. Hitchcock	Gulf
Autometrix	Clifford Instruments	Echometer	H.C. Electronics
Avionics	Climatronics	Edison	Haake
B.K. Elliot	Climet	EG&G Chandler	Halliburton
Bahnson	Cobe Laboratories	EG&G Geometrics	Hameg Instruments
Bardusci	Codex	EG&G Instruments	Harmon Electronics
Barnstead	Coe Manufacturing	Elac	Hartmann-Braun
Bascom-Turner	Cole Parmer	Electro-Nite	Harvard Apparatus
Bausch & Lomb	Coleman	Electrodyne	Healy Ruff
Baxter	Comprobe	Electronic Associates	Heath
Baylor	Computer Devices Inc.	Electronics Corporation of America	Heco
Beacon Sales	Conmed	Electronics for Medicine	Helena Labs
Beck Chart	Connerville Blower	Elmes-Staub	Hellige
Beck-Lee	Consarc	Elnik Instruments	Helwig-Mikkelsen
Beckman Whitley	Contraves-Goerz	Endevco	Henry J. Green
Benmar	Corbin Farnsworth	Enduro Pipeline Services	Hildebrandt
Beta Products	Cordis	Enterra	Hioki
Bio Technology	Corning	Environmental Sciences	Hofler
Bio-Optronics	Cosa Instruments	Environmental Tectonics	Hokushin
Bio-Rad Labs	Coulter Counter	Envirotronics	Hommelwerke
	CRC Wireline Services		Horiba

Product and company names listed are trademarks or trade names of their respective companies.

Howe Richardson Scale	Liquidometer	Odom Hydrographic Systems	Sanyo	Tecline
Hull Corporation	LKB Produkter	Offner	Sargent	Tejas Instrument Engineers
Hycom	Lloyd	Okidata	Satec Systems	Tektronix
Hydro Static Industries	Loral Control Systems	Omniscribe	Scanlan-Morris	Telecom
Hydro-Test Products	Lufft	Orion Research	Schwarzer	Teledyne
Hyoda Gauge Manufacturing	Lumiscope	Ortec	Science Associates	Teledyne Hastings Raydist
I.I. Morrow	Lynn Medical	Orton Ceramics	Scientific Atlanta	Telenav
IBM Instruments	M.C. Miller	Osaka Seimistu Kikai	Scientific Equipment	Telmar
Industrial & Mill Supply	Maag	Ott	Scientific Instrument	Telpar
Industrial Scientific	Machine Control Systems	Oximetrix	Scientific Products	Tencor
Infilco	Magnavox	P.K. Morgan	Scientific Systems	Texas Gage
Infolink	Mahr	Pacific Transducer	Scott Testers	Texas Trading & Transportation
Instru-Met	Mannesmann Kienzle (Argo)	Panasonic	Sealed Unit Parts Company	Thermo Electric
Instrument Corporation of America	Manning Environmental	Pantos	Sefram Paris	Thermo King
Intek	Manning, Maxwell & Moore	Parke-Davis	Seikosha	Thermo Separation Systems
International Machine & Tool	Mano-Ter	Pedersen Instruments	Sensotech	Thermo-X
Interspace Technology	Marathon Temperature Recorder	Penn	Sercomp	Thompson Packard
Ircon	Marelco	Pennant	Serdex	Thurmond McGlothlin
Irvington-Moore	Marsch-McBirney	Permutit Ranarex	Servis Recorder	Thwing-Albert Instrument
ISCO	Marsh-McBirney	Perthen	Servo Corporation of America	Time & Temperature
Isuzu	Martin Decker	Peters	Sharples	Tinius Olsen Testing
ITT Barton	Mast Development	Pfauter Maag	Sheffield	TN Technologies
J.J. Lloyd	Matsushita	Pharmacia Fine Chemicals	Shimaden	TOA Electronics Ltd.
Japan Electro-Optics Lab	Maxwell Manufacturing	Phipps & Bird	Shinko	Tocotonometer
Japan Radio	McCullough Services	Photomation	Short Mason	Tokyo Seimtsu
Jaquet	MDA Scientific	Photovolt	Si-tex	Toledo Scale
Jarrell-Ash	MDT Biologic	Physio Controls	SIE	Tooke
Jasco	Mead	Picker	Siemens	Tracerlab
Jason	Mechtron	Plasser American	Sigma	Travenol Labs
JDL	Mecta	PMC Industries	Sigma Cosa	Tronitec
Jewett	Merrick Scale	Podbielniak	Silent Watchman	Tuboscope
Judson Bigelow	Meteorology Research	Polymer labs	Simplex	Turbitrol
Jules Richard Instruments	Metrohm	Powers	Simrad	Uehling
Jumo	Metrosonics	Pozzi Autoclave	Sippican	UGC Industries
Kahlsico	Meylan Stopwatch	Precimax	Sliver Tester	Unicam
Kay Electric	Micrometrical	Precision Scientific	Sloan	Uniloc
Keitex Superba	Milton Roy	Pulse Electronics	Smith Industries	Union
Keithley Instruments	Miltope	Pye Unicam	Sonceboz	Union Gas Systems
Kelvin Hughes	Mineral Logging Systems	Pyxis	Sonicaid Incorporated	Union Switch & Signal
Kenametal	Minnesota Mining & Manufacturing	R.M. Young	Sony	US Gage
Kentek	Mitsubishi	Radio Holland USA	Sorenson Research	Valmet
Keuffel & Esser	Mitsui Machinery Sales	Radio Shack	Sound Apparatus	Vexilar
Keystone Development	Mitutoyo	Rainhart	Spacelabs	Vollmer
Kiln Skew Deflection	Moeller	Ray Jefferson	Spectrolab	WWR Scientific
Kilowate	Monitor Labs	RDK Corp.	Speedo-Check	Wahl Instruments
Klingelberg	Montana Dakota	Reichert Instrument	Sperry Marine Systems	Wang Labs
Knowles Electronics	Moore Dry Kiln	Remco	Standard Testing Equipment	Warren E. Collins
Kodak	Mortara Instruments	Resuscianne	Star Micronics	Waters Associates
Kokusai	Motorcycle Trace	Revco Scientific	Sterilizer Chart Company	Wedding & Associates
Konel	Murday	Reynolds	Stickle	Well Reconnaissance
Kontron	Myron Lewis	Riehle	Stires Recording	Weston
Lafayette Instrument	Narco Bio-Systems	Rigaku	Stoelting	Wilks Scientific
Lager	Navitronic	RMS Instruments	Stranco	William H. Wahl Instruments
Lancy	NCR	Robinair	Strandberg Engineering	Wilmad Glass
Lasertrak	NDC Systems	Roche	Stress Relief Engineering	Yamatake-Honeywell
Lawson-Hemphill	NDT Systems	Rohm & Haas	Summit Avionics	Yarnall Waring
Leopold	Negretti & Zambra	Ross Labs	Supelco	Yellow Springs Instrument
LFE Corp.	Nicolet Instrument	Rubicon	TA Instruments	Zeiss
Librascope	Norcross	Rusco Electrical Systems	Tamper	Zwick
Lietz	Nova Metrix	Ryan Instrument	Teca	Zymed
	Numeridex	Saco-Lowell	Techni-Rite	
		Santos-Zaghi		

How to Order

Electronic Ordering

For the most efficient and cost-effective ordering, Graphic Controls offers electronic ordering via Electronic Data Interchange (EDI). This system allows you to link your inventory control data directly to our Customer Service, reducing time, paperwork and the chance of errors.

Requests for Quotation

For a price quotation, list the products you've ordered during the past year. Include instrument type, part number and total quantity used. We recommend you check past purchase orders and consult with your instrument engineers and stores keeper to make sure the list is comprehensive.

To have a Customer Service Representative review your requirements, call toll-free 1-800-669-1535 in the U.S., and in Canada 1-800-267-9498.

Filling Out a Purchase Order

To ensure accuracy, please include both the Graphic Controls part number and the manufacturer's name and part number for each product. If you are unsure of the manufacturer's part number, please include a sample of the product you need. Be sure to specify quantities, e.g., number of boxes or rolls needed.

For fastest delivery, please include any special shipping instructions, e.g., special packing, routing or export requirements.

Merchandise Returns

All returned merchandise must be accompanied by a Return Authorization, obtainable by calling our toll-free number. Please have your customer number and the Graphic Controls order number, found on the packing slip, when inquiring about a return.

Product Warranty

The recording charts, pens and ribbons we recommend are carefully selected and have undergone extensive laboratory performance analysis prior to their introduction. We warrant our products are free from defects in material and workmanship and will offer full replacement or credit for charts, pens or ribbons which we supply that are defective and returned by the customer.

Regarding sensitized, non-impact or non-ink charts, we warrant that our products will not cause excessive or abnormal wear to your instrument print head. However, under the following conditions, we will bear the cost of service and repair of machines which are damaged, excluding normal wear and tear, by use of our paper:

1. Signed documentation from a service representative stating abnormal wear can be established as a direct result of exclusive and continuous use of the manufacturer products.
2. Reasonable precautions have been taken in the handling, storage, and use of the manufacturer products.
3. Report of such damage is reasonable and prompt.
4. Damaged print head should be forwarded directly to Graphic Controls, Attn: QA/QC Dept.

Customer Service

USA

Buffalo, New York
800 669-1535
Fax: 800 347-2420

Canada

Gananoque, Ontario
800 267-9498
Fax: 800 267-4521

International (Europe, Middle East)

Controles Gráficos Ibéricos, S.A.
Tel: 34 91 7470444
Fax: 34 91 7477846

International (All Other Countries)

Tel: 716 853-7500
Fax: 716 847-7551

Recording Charts and Markers

Graphic Controls a business unit of The Ludlow Company LP, a Tyco International company is the world's largest facility for the design and manufacturing of circular, strip, rectangular and fanfold recording charts.

We also manufacture the industry's most complete line of disposable pens, pen arms, inks and accessories to fit circular and strip chart recorders of instrument manufacturers worldwide.



Visit us on the web at www.graphiccontrols.com